

Active Power Filter

User manual

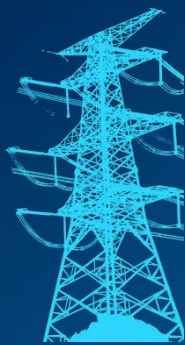
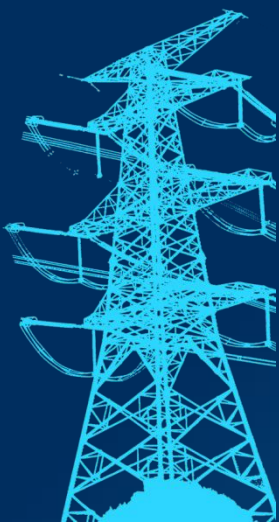

Contents

Preamble.....	3
Safety.....	4
Chapter 1 Arrival inspection and storage.....	6
1.1 Transportation.....	6
1.2 Receive and check the equipment.....	6
1.3 Module Packing.....	6
1.4 Storage.....	7
Chapter 2 Product overview.....	8
2.1 Product appearance composition.....	8
2.1.1 Appearance.....	8
2.1.2 Wall-mounted mounting ears.....	9
2.2.1 Rack-type module.....	9
2.2.2 Wall-mounted.....	10
2.2.3 Standing.....	10
2.3 Technical Specifications.....	11
2.4 Heat dissipation requirements.....	11
Chapter 3 System Installation.....	13
3.1 Tools.....	14
3.2 Installation environment.....	16
3.3 Mechanical installation.....	16
3.3.1 Rack Installation.....	16
3.3.2 Wall mount.....	19
3.3.3 Vertical mounting.....	19
3.4 Electrical connection.....	20
3.4.1 Port overview.....	20
3.4.2 Power terminals.....	21
3.4.3 Communication ports.....	22
3.4.4 Control ports.....	23
3.4.5 Current transformer.....	24
3.4.6 Power distribution for single machines.....	26
3.4.7 Parallel power distribution.....	27
Chapter 4 Stand-alone Trial Run.....	32
4.1 Recheck.....	32
4.2 Power on the APF.....	32
4.3 Power off the APF.....	33
4.4 Manual/Automatic Operation.....	34
Chapter 5 Parallel trial operation.....	35
5.1 Reheck.....	35
5.2 Power on the APF.....	35
5.3 Power off the APF.....	36
5.4 Manual/Automatic operation.....	37
Chapter 6 Menu with 4.3-inch Screen.....	38
6.1 LCD Home page.....	38

6.2 Data page.....	39
6.2.1 Power Grid Data.....	39
6.2.2 Load Data.....	40
6.2.3 APF Data.....	41
6.3 Setup page.....	41
6.4 Fault page.....	42
6.5 Switch page.....	43
6.6 Example of operation Settings.....	45
6.6.1 Setting CT ratio.....	45
6.6.2 Setting the CT Position.....	46
6.6.3 Setting Boot Mode.....	46
6.6.4 Setting harmonic compensation times.....	47
6.6.5 Setting the phase sequence.....	48
Chapter 7 Human-computer interaction interface.....	49
Chapter 8 Care and Maintenance.....	50
8.1 Pre-maintenance attention.....	50
8.2 Maintenance content and cycle.....	50
8.3 Maintenance steps.....	52
Chapter 9 Common troubleshooting.....	53
Appendix.....	56
1. 400V-150A/200A and 690V-100A appearance schematic.....	56
2. Background forwarding instructions and interface definition.....	57

Preamble

In order to help you better use the product and protect your safety and the safety of the product, please carefully read and understand the relevant safety information and information about the equipment and user manual before operating the product.

Disclaimer

Following the contents of the user manual is a prerequisite for safe operation, as well as achieving the performance characteristics and product functions described;

Our company does not assume the responsibility for material loss, economic loss and personal injury caused by ignoring product information;

Copyright Notice

Our company reserves the right of final interpretation of this manual. It is forbidden to copy, modify or disseminate the content of this manual without permission.

Technical changes

Please carefully read and understand the information related to the product;

Please keep this manual during the service life of the product to avoid unnecessary use;

As the product is constantly updated and upgraded, the place of upgrading is not subject to prior notice;

Warranty service

In the shelf life of the product, due to product quality problems can enjoy free after-sales service;





Do not attempt to disassemble, repair, modify or upgrade the equipment, otherwise all warranty services will be invalid.

Safety

This instruction is very important for the installation and use of active power filters (APFs). Ignoring these instructions may cause bodily injury or even death to you. The following safety information outlines the safety measures required for the operation of the equipment and its components. Please follow the safety tips and safety information to ensure your personal safety and avoid material and economic losses.

1. The symbols used

Safety information is marked with symbols, and according to the danger level, the danger level is shown as follows:

 Pay attention	Always be aware of dangerous situations that may arise, which may result in minor injuries if left unattended.
 Be careful	Always be aware of dangerous situations that may arise, which may result in moderate injury if left unattended.
 Warning	Always be aware of possible dangerous situations that could result in serious injury if left unattended.
 Danger	Always be aware of electrical hazards.

2. Precautions

When operating electrical equipment, it is inevitable that some parts of the APF equipment will produce dangerous voltage. Serious physical injury or equipment damage can result if not handled properly.

◆ APF equipment is suitable for 0.2/0.4/0.48/0.69KV power supply system, it is strictly prohibited to connect to the power grid without understanding, so as not to cause equipment damage and personal safety harm!

Improper use will damage the active power filter and connected equipment;

All system installation or routine maintenance must be operated in the case of power failure;

◆ It is strictly prohibited to place combustible materials near the APF equipment or install them in the environment containing explosive gas, otherwise there is the risk of fire or even explosion;

◆ Confirm that the input power supply is completely disconnected before installation and wiring operation, otherwise there is the risk of electric shock; After power-on, except the LCD screen, do not touch other

parts of the APF equipment;

- ◆ Exposed cables, power terminal connectors and ungrounded live equipment may cause electric shock. Ask an electrical engineer or professional technician to verify that the APF equipment is fully grounded and to determine the live parts of the connectors and components; Use appropriate safety protective clothing and test tools when operating, and comply with safety practices;
- ◆ Do not maintain the APF equipment in working condition;
- ◆ When maintaining the product, please be sure to cut off the main circuit and wait at least 15 minutes to ensure that the AC side voltage drops to 0V and the internal capacitor is fully discharged;
- ◆ In the humid condition, the resistance of the human body will decrease, at this time there may be dangerous high current through the human body, so do not maintain, install APF in the humid place. When it is impossible to avoid working in the conditions, you can stand on a dry rubber pad or dry board and use insulating gloves to keep your clothes dry and work in the company of a companion.

3. Have a person with electrical qualifications

To avoid personal injury and material damage, only personnel with professional electrical qualifications are allowed to operate and work on the APF equipment and its components, assemblies, systems and current circuits, and they must have the following knowledge:

- ◆ National and international Regulations on the Prevention of Electrical Safety Accidents;

National standards for power supply technical standards of safety prevention system and technical specifications for low-voltage electrical safety;

- ◆ Installation, commissioning, operation, disconnection, grounding and marking of electrical equipment;

Basic requirements on personal protection.

Chapter 1 Arrival inspection and storage

1.1 Transportation

Each set of active power filter (APF) is generally through carton packaging (default carton, optional wooden box) after transportation, the carton is placed with buffer foam cotton and other protective items, but in the transportation and handling process can not be inverted or tilted, so as to ensure that the filter is not damaged in the process of moving.

1.2 Receive and check the equipment

The APF equipment has been professionally tested and inspected before leaving the factory, and prepared for transportation according to the requirements of safe transportation. However, during the long distance transportation, the fixed parts on the APF equipment may still become loose due to vibration and turbulence, so after receiving the equipment, please check as follows:

- ◆ After the equipment is shipped to the site, please check the goods according to the delivery list. If there is any abnormal situation, such as broken packaging, obvious deformation of equipment, equipment quantity is not consistent with the delivery list, please sign the carrier for confirmation, and contact the manufacturer immediately;
- ◆ When removing the equipment packaging, please pay attention to avoid violent dismantling. When you use scissors, pliers, etc., to remove the packaging, please be careful to avoid scratching and damaging the equipment;
- ◆ Check whether there is any external damage on the equipment, such as scratches on the panel, paint off, sag, etc., observe whether there are fallen components and loose wiring in the equipment. If there is damage in transportation, logistics claims should be requested. If you need assistance in the process of claiming, please contact the company;
- ◆ Check the specifications and models. Our APF equipment enclosures have prominent nameplate labels that clearly describe the equipment model number, rated capacity and other information. Please double check that the invoice, goods received are consistent with the delivery list.

1.3 Module Packing

Module packaging is divided into cartons and wooden cases, which are generally cartons by default. If wooden case packing is required, please make remarks in advance.



Figure 1-1 Appearance of the rack

1.4 Storage

- ◆ The packaging of APF equipment avoids long-term outdoor storage, can be stored indoors for 6 months (from the date of delivery), if you need to store longer time, you can put forward to the company to make longer storage time packaging when ordering;
- ◆ If the APF equipment is not immediately installed and used, the APF equipment should be placed in a dry, ventilated, dust-free, non-corrosive material warehouse, and there is no strong mechanical vibration and magnetic field;

Storage environment temperature: (-45°C~70°C), air relative humidity: (5%~95%) (below 25°C);

- ◆ If long-term storage is required, please check regularly whether the equipment packaging is moldy, damaged, etc.

Chapter 2 Product overview

2.1 Product appearance composition

APF series products can be divided into rack type, wall type and vertical type according to the installation mode. Each type of installation mode module has products with voltage levels of 200V/400V/480V and 690V, and the product capacity covers 50A~200A.

The 4.3-inch LCD display is an optional component of the module. You can choose whether to have a screen or not according to the demand.

2.1.1 Appearance

Take the rack-mounted 100A module with screen.

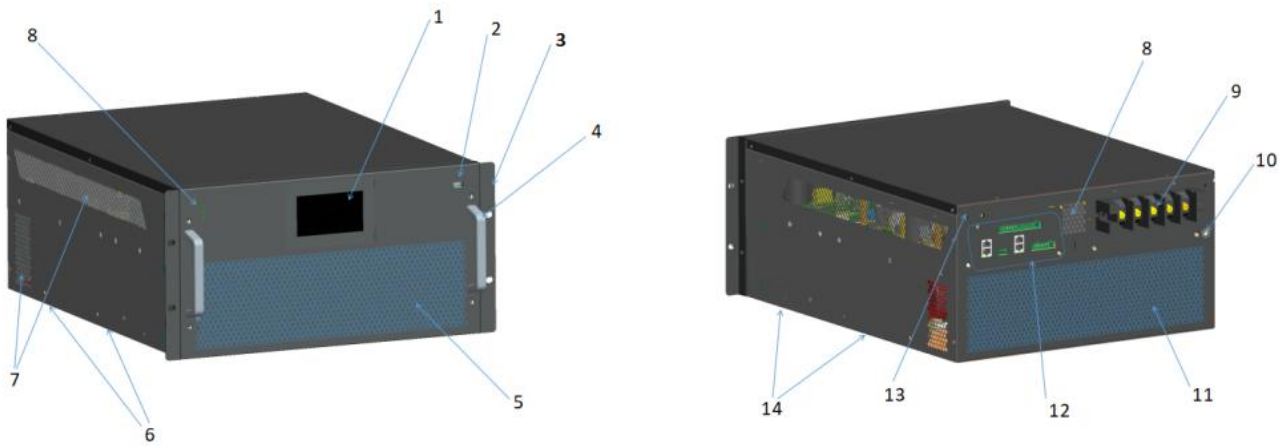

Figure 2-1 Appearance of the rack

Serial number	Instructions	Serial number	Instructions
1	4.3-inch LCD display (optional)	8	Upper heat dissipation hole
2	USB port (can flash reprogramming)	9	Power terminals
3	Rack mounted hanging ears	10	PE ground terminal
4	Hold hands	11	Lower back heat sink hole
5	Lower front panel heat dissipation hole	12	Control terminals
6	Wall-mounted mounting ear holes	13	Reserve WIFI antenna ports
7	Side heat dissipation holes	14	Wall mounted ear mounting holes

***APF Rack mounted Series 400V voltage class 150A/200A and 690V voltage class 100A Appearance** The upper part of the front panel has left and right heat dissipation holes. Otherwise, please refer to Appendix 1, which is not shown here.

2.1.2 Wall-mounted mounting ears

Wall-mounted mounting ears are standard accessories for wall-mounted modules. Wall-mounted mounting ears can also be installed for auxiliary reinforcement installation for modules of all capacity specifications in rack.

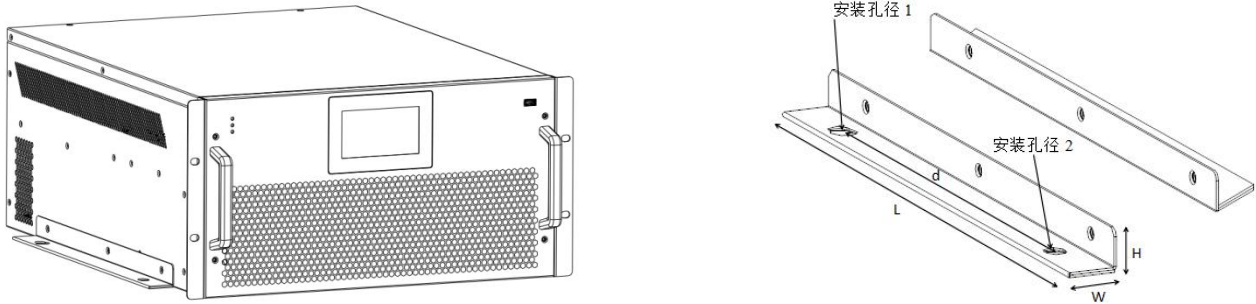

Figure 2-2 Mounting ear diagram

Voltage level	Capacity	L*W*H (mm)	Hole spacing d (mm)	Mounting aperture 1	Mount Aperture 2
200V /400V /480V	50A	395 * 31.5 * 26.5	300	2 - Φ 12	2 - Φ 12 * 16
	75A	455 * 31.5 * 26.5	360	2 - Φ 12	2 - Φ 12 * 16
	100A	395 * 31.5 * 26.5	300	2 - Φ 12	2 - Φ 12 * 16
	150A	395 * 31.5 * 26.5	300	2 - Φ 12	2 - Φ 12 * 16
	200A	495 * 32.0 * 40.0	420	2 - Φ 13	2 - Φ 13 * 16
690V	100A	395 * 31.5 * 26.5	300	2 - Φ 12	2 - Φ 12 * 16

2.2 Overall Dimensions

Under the same specifications, the non-screen module has the same dimensions as the module with screen. The following takes the module with screen as an example.

2.2.1 Rack-type module

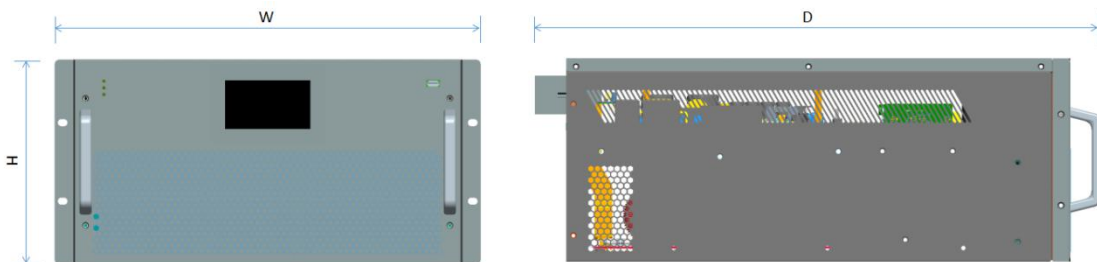

Figure 2-3 Rack size diagram

Project	200V/400V/480V					690V
Capacity (A)	50A	75A	100A	150A	200A	100A
Dimensions W*D*H (mm)	359 * 538 * 200	399 * 626 * 200	484 * 646 * 232	554 * 656 * 250	674 * 715 * 250	569 * 697 * 250
Weight (kg)	22	27	38	47	56	50

2.2.2 Wall-mounted

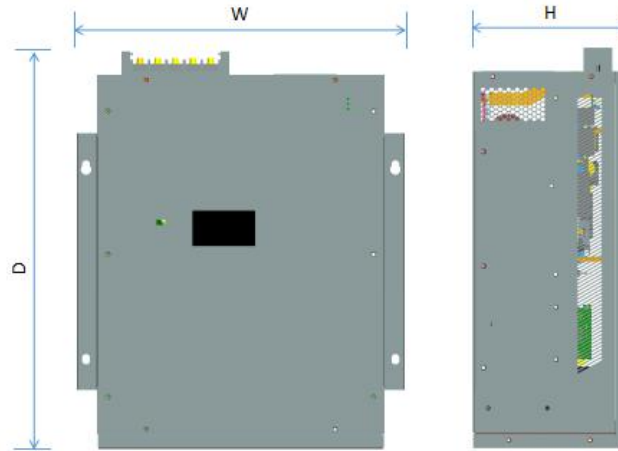

Figure 2-4 Wall mounted dimensions diagram

Project	200V/400V/480V					690V
Capacity (A)	50A	75A	100A	150A	200A	100A
Dimensions W*D*H (mm)	378 * 525 * 200	418 * 556 * 200	503 * 611 * 232	573 * 621 * 250	694 * 680 * 250	588 * 662 * 250
Weight (kg)	22	27	38	47	56	50

2.2.3 Standing

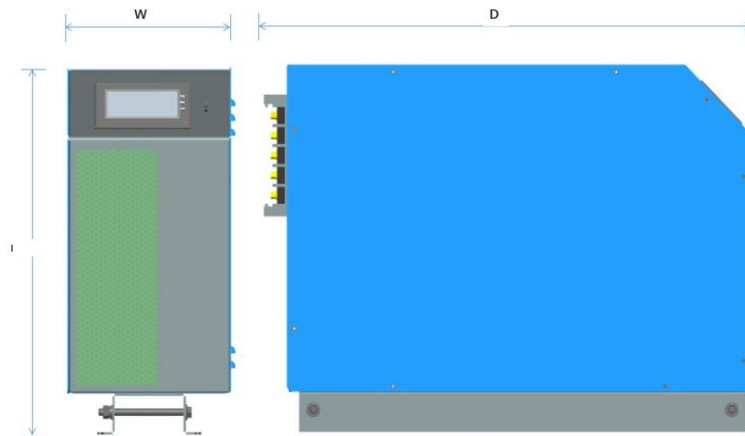

Figure 2-5 Dimensions of a stand

Project	200V/400V/480V					690V
Capacity (A)	50A	75A	100A	150A	200A	100A
Dimensions W*D*H (mm)	202.2 * 575 * 372.4	202.5 * 638 * 418	234.5 * 699 * 498	251.5 * 689 * 568	251.5 * 748 * 688	251.5 * 755 * 583

Weight (kg)	22	27	38	47	56	50
-------------	----	----	----	----	----	----

2.3 Technical Specifications

Rated voltage (V)	200/400	480	690
Input voltage range	- 20% ~ + 20%	Maximum voltage: 500V	- 20% ~ + 10%
Single module capacity (A)	50, 75, 100, 150, 200	50, 75, 100, 150, 200	100
Frequency	50/60Hz (-10%~+10%)		
Filter range	2 to 50 times optional		
Harmonic filtering capability	Better than 97% at rated load		
CT mounting method	Open or closed loop (Open loop is recommended in parallel)		
CT mounting position	Grid side/load side		
Response time	10 ms or less		
Wire system	Three-phase three-wire/three-phase four-wire		
Overload capability	It can run continuously at 110% rated current and 1min at 120% rated current		
Circuit topology	Three-level topology		
Switching frequency	20 kHz		
Number of parallel machines	Parallel between modules	≤ 20	
	Parallel machine under HMI control	No more than 8 modules are parallel	
Redundancy	Any unit can become a stand-alone unit		
Unbalanced governance	Available		
Reactive power compensation	Available		
Display	No screen /4.3/7 inch screen (optional)		
Communication port	RS485		
	CAN protocol, RJ45 interface, for communication between modules		
Noise level	< 56 dB Max to < 69 dB (depending on module or load conditions)		
Altitude	>1500m derating use		
Ambient temperature	Operating temperature: -45°C~55°C, derating above 55°C for use		
	Storage temperature: -45°C~70°C		
Humidity	5% to 95%RH, no condensation		
Cooling mode	Smart air cooling		
Level of protection	IP20		
General structural and safety issues	EN 62477-1(2012), EN 61439-1 (2011)		
EMC	EN/IEC 61000-6-4, Class A		
Certification	CE, CQC		

2.4 Heat dissipation requirements



APF module adopts intelligent air cooling heat dissipation. When designing complete sets of systems, the heat dissipation design should meet the following requirements:

Voltage level	Product capacity	Demand air volume (L/Sec)	Minimum air intake area (mm)	Minimum opening size of front and rear door Panels (mm)
200V	50A	150	2.6 * 10	383 * 87

/400V /480V	75A	225	3.0 * 10	383 * 100
	100A	300	3.5 * 10	383 * 120
	150A	450	5.5 * 10	430 * 140
	200A	525	6.3 * 10	520 * 160
690V	100A	450	5.5 * 10	430 * 140

For example, the complete cabinet of APF-400A shall be designed for heat dissipation 4 times that of APF-100A module (required air volume, minimum air intake area, minimum opening size of front and rear door panels).







Chapter 3 System Installation

 <p>Note</p>	<ul style="list-style-type: none"> ◆ APF modules have the same signal interface, APF-100A (including 100A) above the power terminal has two N-phase terminals, and the two N-phase terminals need to connect; <p>The installation and connection modes of the module without screen are the same as those of the module with screen;</p> <ul style="list-style-type: none"> ◆ The module can be monitored by a 4.3-inch small screen (optional) or by an external 7-inch large screen (optional).
 <p>Be careful</p>	<ul style="list-style-type: none"> ◆ Provide adequate air circulation in the installation environment. When the ambient temperature is high, please conduct certain cooling of the APF equipment as required; Install the APF according to the instructions in this manual and related accessories; ◆ Install the rack module, please install it horizontally. Try not to tilt, handstand and other directions for installation; ◆ Install wall hanging module, as far as possible wall hanging vertical installation, do not hang side or upside down; <p>Install vertical module, avoid tilt, lodging installation.</p>
 <p>Warnings</p>	<p>As ignoring the installation instructions can easily cause equipment damage, which may endanger personal safety in serious cases, please strictly follow the following rules:</p> <ul style="list-style-type: none"> ◆ Before starting work, please disconnect the isolation switch and make sure it can not be closed by someone, and check that the APF has been cut off! Temporarily cover adjacent live parts with insulation; ◆ In the process of operation and troubleshooting, please check in advance whether there is dangerous voltage in the environment, if necessary, please turn them off; ◆ When working on the electrical system, please wear protective clothing and equipment according to the applicable guidelines; <p>Before connecting the equipment/parts, please keep the ground and ensure the equipment power off;</p> <p>Do not contact the energized bare or peeling wire, stranded wire should be equipped with wire sleeve;</p> <ul style="list-style-type: none"> ◆ All parts of the circuit connected to the power supply/grid may have dangerous voltage; ◆ Use suitable line isolation switches/circuit breakers/fuses; ◆ Dangerous voltages may still exist in the equipment or components (capacitors) even when disconnected from the power supply/grid; <p>Do not operate the equipment when the current transformer circuit is open;</p> <p>Do not make the APF equipment run with full load for a long time, and do not set the</p>

parameter beyond the limit value that the equipment can bear;
 Please pay attention to the warning and safety marks of all documents related to the equipment;
 ◆ Please pay attention to all warning and safety marks in the site environment.

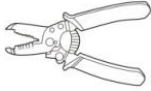
3.1 Tools

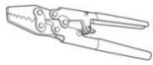
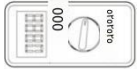
Prepare the tools that may be used for installation and wiring in advance. Only some of the tools that may be used are listed here for reference only.

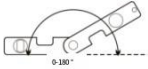
Number	Tools	Description	Features
1		Hammer drill	Wall drilling
2		Flat-head screwdriver	Remove and install screws as well as wiring
3		Phillips screwdriver	Remove and install screws as well as wiring
5		Wire strippers	Wire stripper
6		Hex wrench	Holding module
7		Crimping pliers	Crimp communication and control terminal wiring And crimp CT extension cords
8		Multimeter	Check that the cable is wired correctly, Whether grounding is reliable
9		Marker	Punch marks
10		Measuring tape	Measuring distance
11		Level	Keep the module level

12		Insulation protective gloves	Wear when installing the machine
----	---	------------------------------	----------------------------------

3.2 Installation environment

(1) Site requirements

- ◆ APF equipment must be installed in the electrical control room, the room must maintain good ventilation environment;
- ◆ The air inlet and outlet must be professionally rainproof, dust-proof, sand-proof, fireproof and rodent-proof;
- ◆ If there are serious dust and fly ash problems in the installation site, it is recommended to equip the APF equipment with special protective treatment, to avoid reducing the efficiency of the equipment, reducing the service life, failure and damage.

(2) Foundation requirements

- ◆ The installation surface must be smooth and dry, the ground is strictly prohibited water; Ensure that the ground level does not shake, the land is strong, can bear the weight of the APF device.

(3) Space requirements

- ◆ In the APF equipment before and after the left and right direction to reserve enough space (at least 30cm) for heat dissipation;
 - ◆ APF equipment should be far away from flammable, explosive and corrosive materials; Adequate space should be reserved around the APF equipment for operation wiring and future maintenance;
- The installation position must conform to the fire safety regulations.

(4) Environmental requirements

- ◆ It can run with full load when the altitude is lower than 1500m; At 1500m-4000m altitude according to the national standard GB/T3859.2, every 100m rise, the power is reduced by 1%;
- Humidity: 5~95%, no condensation;
Ambient temperature :-45°C~55°C.

3.3 Mechanical installation

Mechanical installation can be divided into rack installation, wall installation and vertical installation according to the module installation method.

3.3.1 Rack Installation

For rack-mounted installation, the front two mounting ears of the module can be fixed to the cabinet mounting posts (as shown below), or the installation can be strengthened by selecting wall-mounted mounting ears (refer to 2.1.2).

The handrails on the front panel of the module are held as auxiliary installation only, and cannot be used for load bearing!

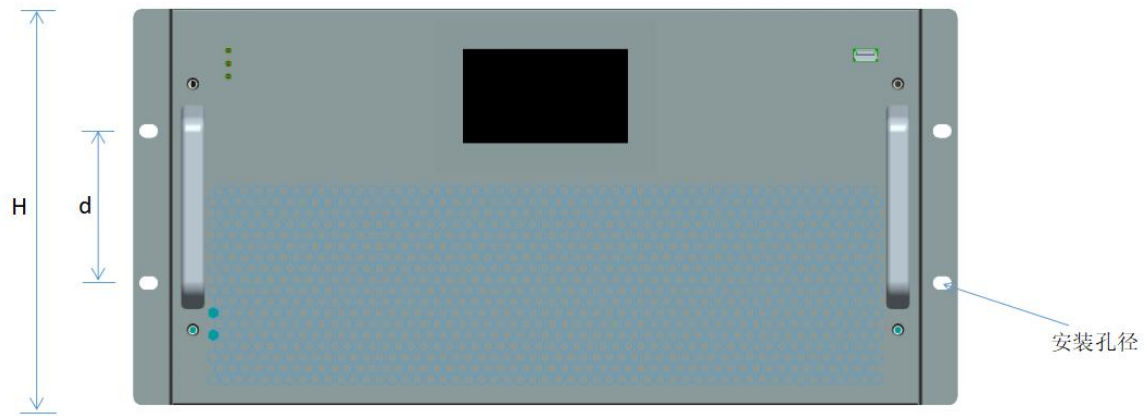
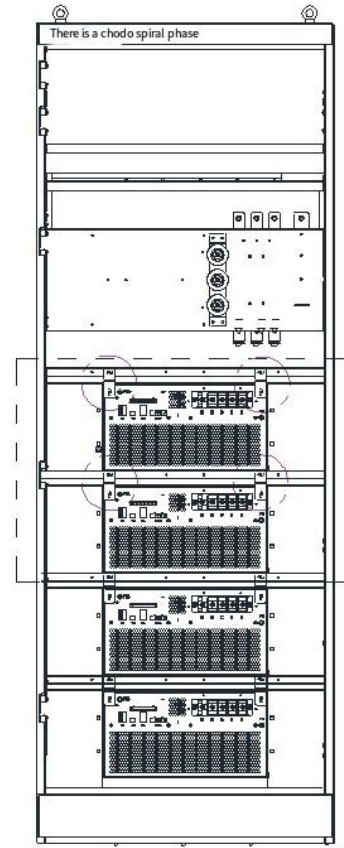
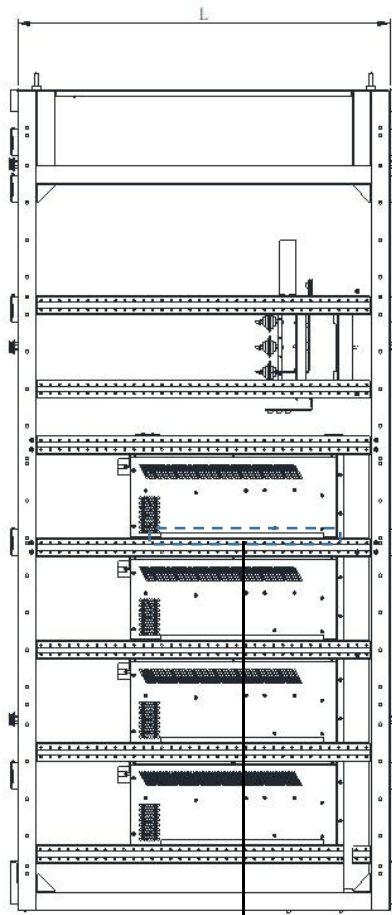
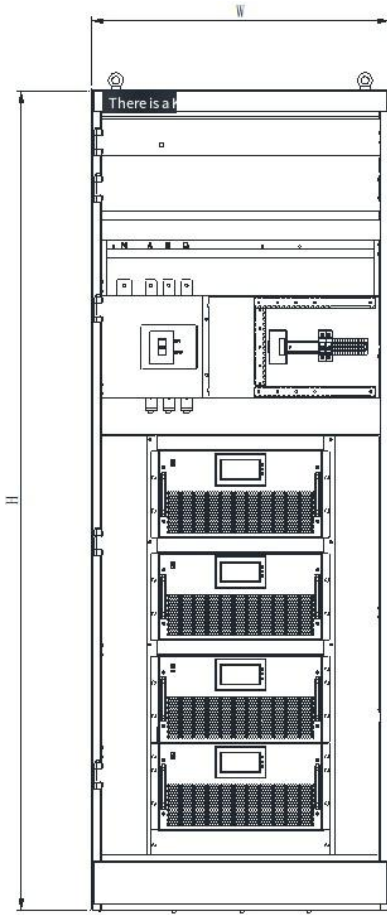

Figure 3-1 rack-mounted front panel

Voltage level	Capacity	H (mm)	d (mm)	Mounting aperture
200V /400V /480V	50A	200	89	4-8 * 11
	75A	200	89	4-8 * 11
	100A	232	89	4-8 * 11
	150A	250	89	4-8 * 11
	200A	250	89	4-8 * 11
690V	100A	250	89	4-8 * 11

Take the 400A active filter cabinet (4 100A modules) as an example:

	Recommended size W*L*H (mm)
Active filter cabinet	800 * 800 * 2200
	800 * 1000 * 2200
	1000 * 1000 * 2200



*Module back fastener

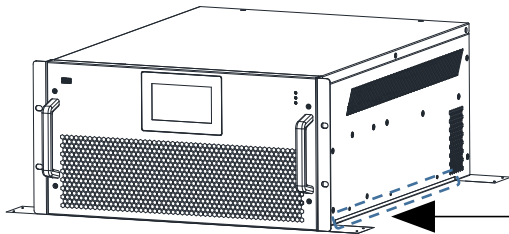

* The gap between guide rail and module is 2mm

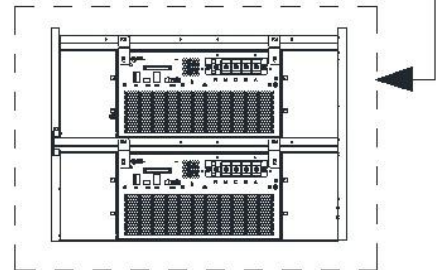

3.3.2 Wall mount

For wall-mounted installation, it must be fixed in the cabinet or on a hard wall through the left and right wall-mounted mounting ears.

Voltage grade	Capacity	Mounting aperture 1	Mount Aperture 2	Hole spacing d (mm)
200V /400V /480V	50A	2 - Φ 12	2 - Φ 12 * 16	300
	75A	2 - Φ 12	2 - Φ 12 * 16	360
	100A	2 - Φ 12	2 - Φ 12 * 16	300
	150A	2 - Φ 12	2 - Φ 12 * 16	300
	200A	2 - Φ 13	2 - Φ 13 * 16	420
690V	100A	2 - Φ 12	2 - Φ 12 * 16	300

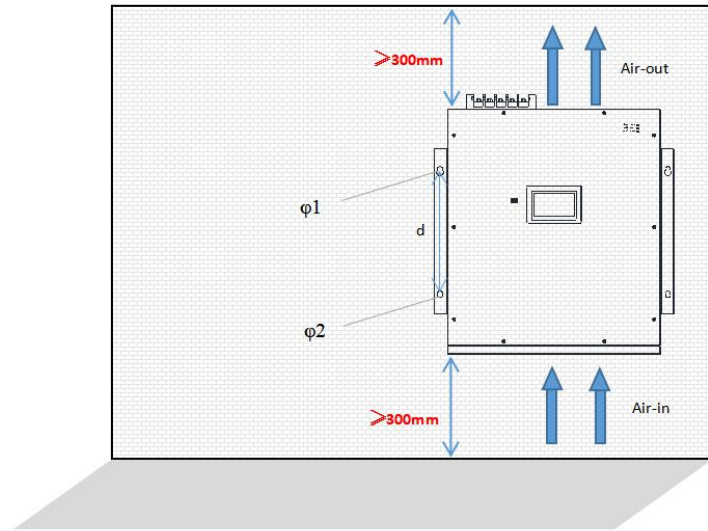
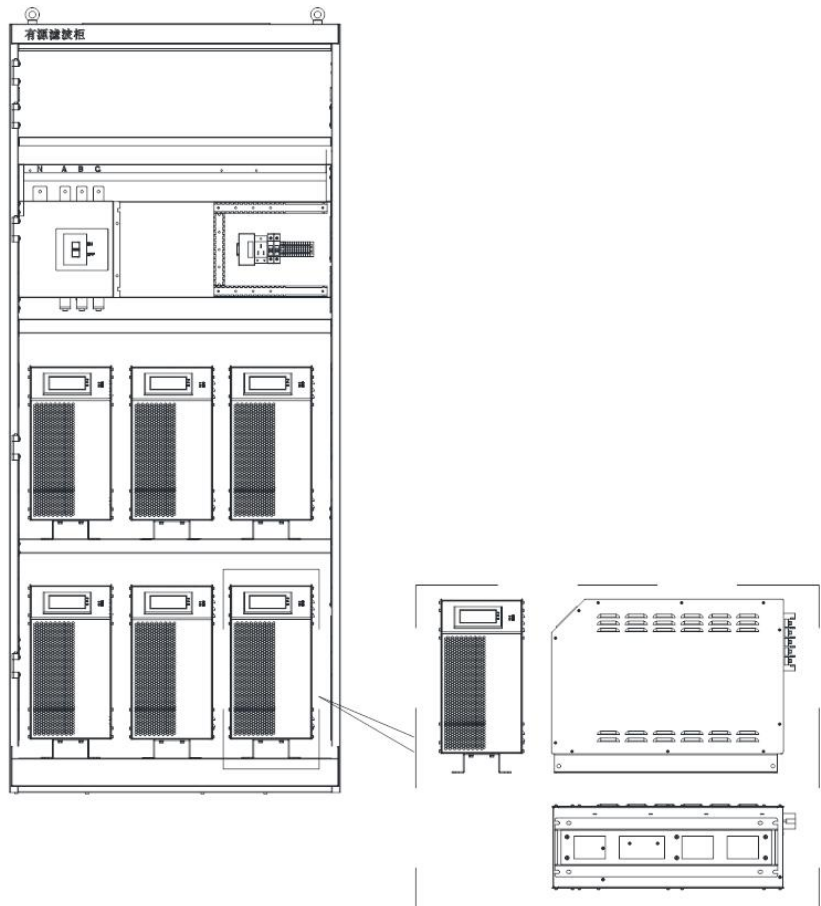

Figure 3-3 wall mount diagram

3.3.3 Vertical mounting

In vertical installation, the APF module is fixed in the cabinet through the lower guide rail and screws. Take the 600A active filter cabinet (composed of 6 100A modules) as an example:

	Recommended size W*L*H (mm)
APF cabinet	800 * 800 * 2200
	800 * 1000 * 2200
	1000 * 1000 * 2200



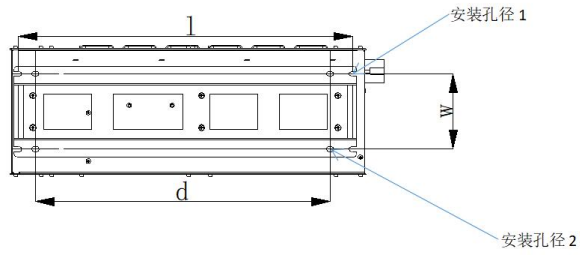

Figure 3-4 Vertical installation diagram

Voltage Grade	Capacity	Installation Aperture 1	Mounting Aperture 2	Hole spacing l (mm)	Hole spacing d (mm)	Width w (mm)
200V /400V /480V	50A	4 - Φ 9	4 - Φ 9 * 15	511	440	140
	75A	4 - Φ 9	4 - Φ 9 * 18	595	440	140
	100A	4 - Φ 9	4 - Φ 9 * 14	625	550	140
	150A	4 - Φ 9	4 - Φ 9 * 14	640	550	140
	200A	4 - Φ 9	4 - Φ 9 * 14	686	600	215
690V	100A	4 - Φ 9	4 - Φ 9 * 14	687	616	140

Note

- ◆ It is recommended to put no more than 3 vertical modules in each layer of the cabinet;
- The cabinet beam and the bottom should be thickened and reinforced to avoid being crushed due to the weight of the module;**
- ◆ The center of gravity of module installation should be as low as possible.

3.4 Electrical connection

3.4.1 Port overview

APF module ports are divided into power terminals, communication ports (which can be divided into monitoring ports, debugging ports and parallel communication ports), control ports and CT.

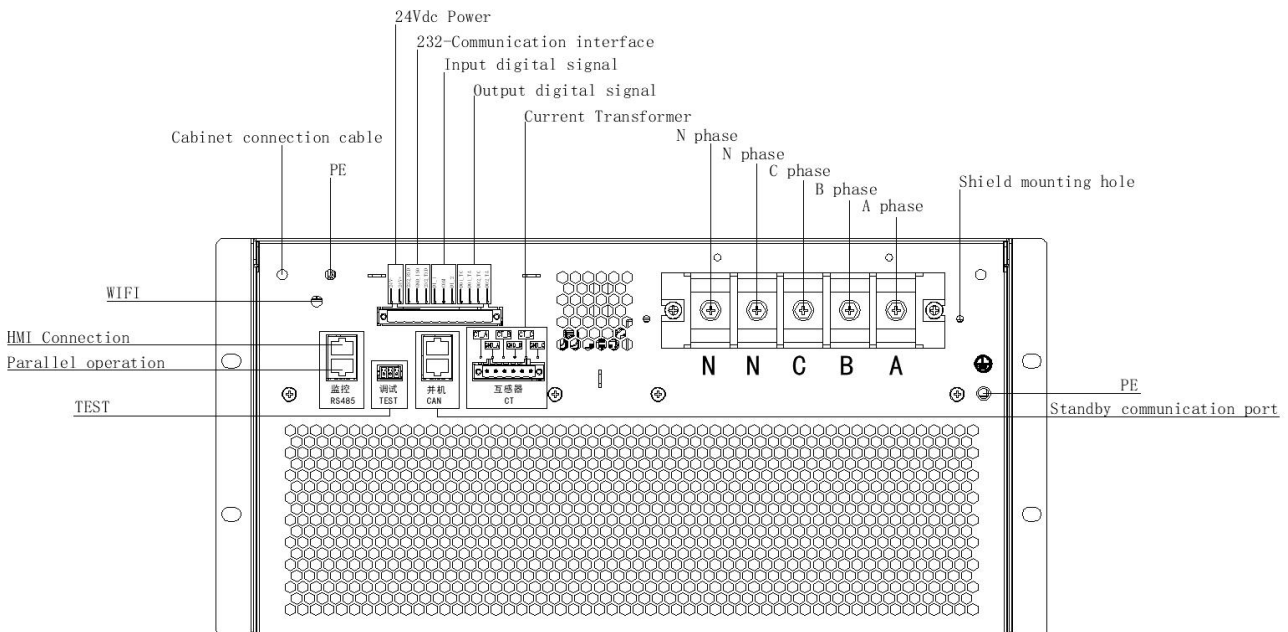



Figure 3-5 Back overview

3.4.2 Power terminals

 Warnings	<ul style="list-style-type: none"> ◆ Power terminal wiring must be connected correctly, please be sure to check several times: do not miss, do not mix, otherwise it may cause equipment failure or damage; ◆ Please keep the power terminal dry, can be protected if necessary; ◆ Power terminal is conductive material, please do not touch it with your hand!
---	---

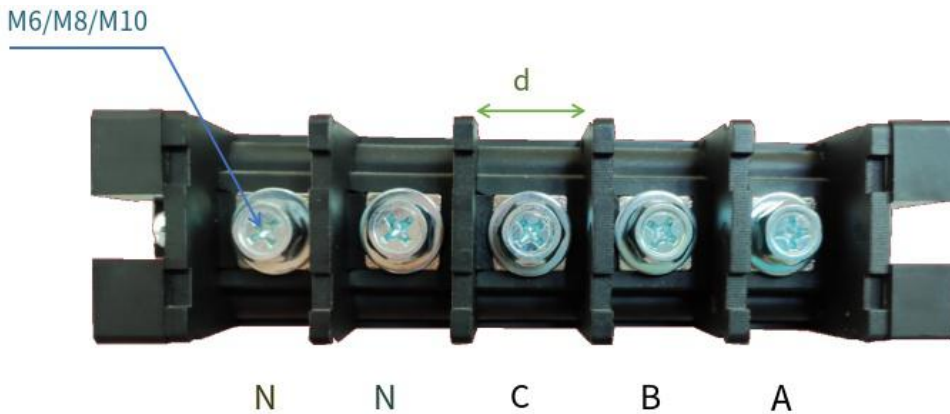

Figure 3-6 Power terminal diagram

(1) Meaning of the terminal

Item	Instructions
A	A-phase input
B	B phase input
C	C phase input
N	N phase input
N	N phase input
PE	Ground terminal

Voltage level	Capacity	Power terminal specifications	Terminal Width d	PE ground post
200V /400V /480V	50A	M6	13mm	M6
	75A	M8	23mm	M6
	100A	M8	23mm	M6
	150A	M8	23mm	M6
	200A	M10	30mm	M6
690V	100A	M8	23mm	M6

(2) Recommended cables

Items	Capacity	A/B/C (L1/L2/L3)	N	N	PE	Fuse A
Power cable	50A	16mm ²	25mm ²	-	16mm ²	80
	75A	25mm ²	35mm ²	-	16mm ²	125
	100A	35mm ²	35mm ²	35mm ²	16mm ²	160
	150A	50mm ²	50mm ²	50mm ²	25mm ²	250
	200A	70mm ²	70mm ²	70mm ²	25mm ²	400
Copper core cable is recommended						

3.4.3 Communication ports

 Warnings	<p>Do not debug the TEST port without the manufacturer's authorization! If you modify the parameters without authorization, it may cause equipment failure or even equipment damage, the company will not be responsible!</p>
--	---

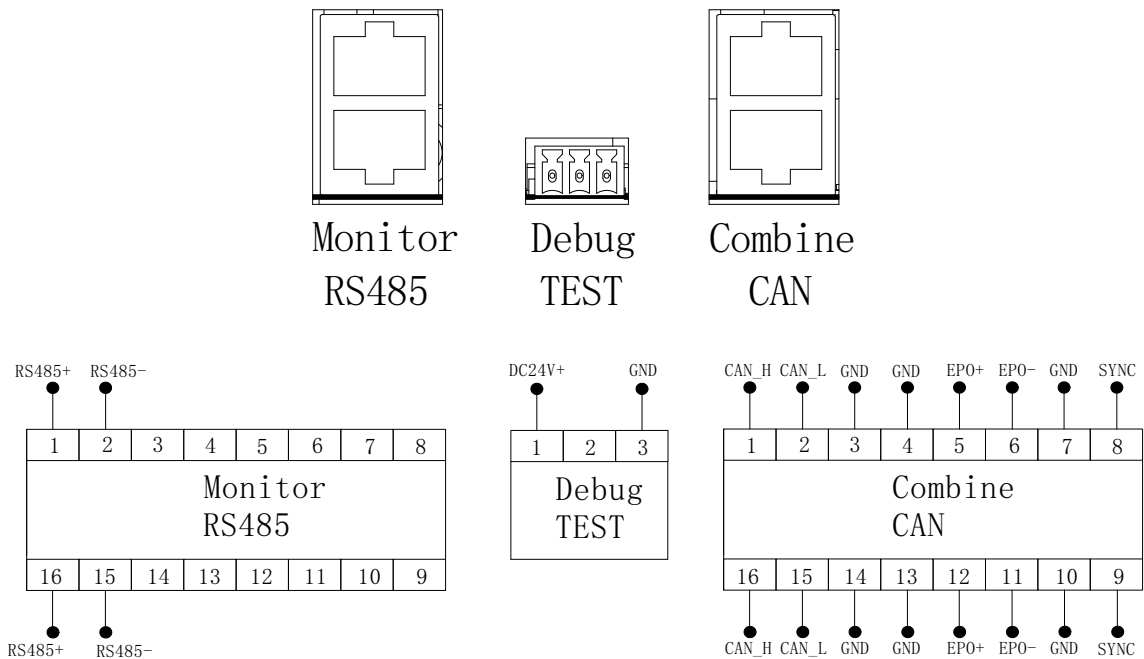

Figure 3-7 Communication port and definition

Name	Definition	Instructions	Notes
Monitoring RS485	RS485 Communication network port	<p>RS485 port: used to connect the background computer control system or external screen display, to realize real-time monitoring of the entire APF configuration system; In addition to the first APF module, it is used to connect the upper port of the next APF module to establish parallel connection (refer to Section 3.4.7).</p> <p>RS485 lower port: When there is only one APF module, it can be empty; When multiple modules establish parallel communication, the lower port can be used to establish communication between parallel modules</p>	Follow the "top to top, bottom to bottom" principle
Debugging TEST	Test Debug interface	TEST port for manufacturers to debug the equipment testing special power-on interface (DC 24V input)	Special for debugging
Parallel machine CAN	CAN Parallel port	When the APF module is normally combined, the CAN port can be empty; When the module controls the capacitor (optional), CAN port parallel is used.	Follow the "top to top, bottom to bottom" principle

3.4.4 Control ports

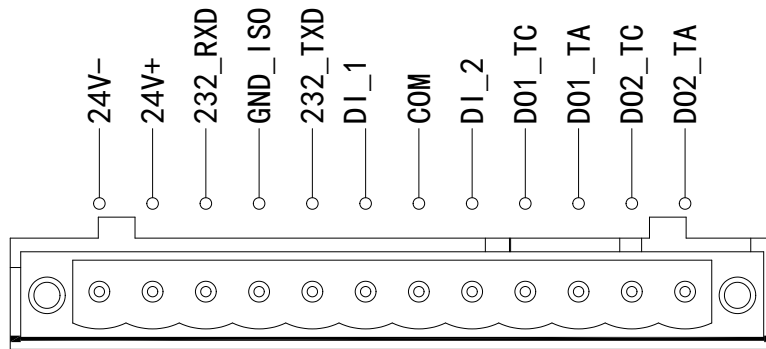
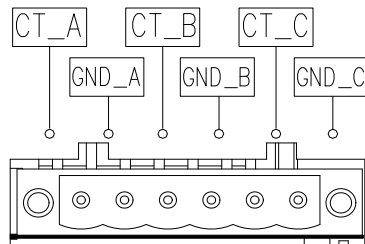

Figure 3-8 Control port diagram

Project		Terminal symbol	Terminal function description	Electrical specifications
Control terminals	24V output	24V-	24V - negative end	24V output, 1Amax
		24V+	24V + positive end	
	RS232	232_RXD	232 Receiving end	RS232 interface, 9600 baud
		GND_ISO	232 ground terminal	
		232_TXD	232 Sending end	
	Digital input	DI_1	Numeric input port 1	The optocoupler isolates the input Input voltage: 9 to 24 Vdc Input impedance: 5kΩ
		COM	Digital input common end	
		DI_2	Digital input port 2	
	Digital Output	DO1_TA	Relay output 1 neutral end	TA-TC: normally open contact; Contact capacity: 250Vac/2A(cosφ=1), 30 Vdc /1A
		DO1_TC	Relay output 1 Always start	
		DO2_TA	Relay output 2 neutral end	
		DO2_TC	Relay output 2 normal start	

3.4.5 Current transformer



Current transformer
CT

Figure 3-9 CT port diagram

Ct connection:

Items	Instructions	Project	description
CT_A	Connect the S1 end of the phase A CT	GND_A	Connect to the S2 end of phase A CT
CT_B	Connect the S1 end of the phase B CT	GND_B	Connect to the S2 end of phase C CT
CT_C	Connect the S1 end of the phase C CT	GND_C	Connect to the S2 end of phase C CT

Items	Parameter requirements		
	CT rated load	Wire cross-sectional area	Length of one-way wiring
CT cable	5VA	The 2.5 mm	10m or less
		The 4.0 mm	10m~20m
	10VA	The 2.5 mm	20m or less
		The 4.0 mm	20~40m
	15VA	The 2.5 mm	30m or less
		The 4.0 mm	30~60m

- (1) secondary power greater than 1VA;
- (2) accuracy requirements above 0.5 grade;
- (3) **CT ratio range is: 50/5~ 2000/5**, the ratio specification is selected by 1.2~1.5 times of the system current. In practical engineering, the selection can also be made according to 1.5 times of transformer capacity (400V). For example, if the transformer capacity is 2000kVA, 1.5 times can be selected as 3000/5;

(4) The secondary side of CT must be reliably grounded (only one end can be grounded). Shielded twisted-pair cable (RVVP) is recommended for transformer sample cables. The internal diameter of 15m is 2.5mm^2 , and the line of 15m~30m is 4mm^2 .



Attention

◆ External CT is recommended to be installed on the load side;

As an external part of APF, the current transformer plays a vital role in the normal operation of APF, so the selection of the external current transformer is very important, please be sure to refer to the above instructions for selection;

If the current transformer is not connected correctly, it may cause insufficient filtering effect or equipment failure;

Before installing the current transformer, short circuit the secondary side and power off the equipment;

Before separating the current transformer and APF, you can short circuit it;

◆ After measuring the load current, the choice of transformer should leave a certain margin.



Warnings

◆ When wiring CT, the outgoing terminals S1 and S 2 of CT are connected to the positive terminal (CT_A) and the negative terminal (GND_A) of the APF device respectively. Please refer to 3.5.5 and 3.5.6.

◆ The P1 end of CT faces the power side, and the P2 end faces the load side;

◆ S1 and S2 of each transformer must correspond to terminals with corresponding labels. It is strictly prohibited to open the circuit twice. Violation of this rule may cause the transformer to burn down;

Ensure that the current transformer is in the short-circuit state until the CT terminals of the APF are connected properly.

3.4.6 Power distribution for single machines

Take load side sampling as an example:

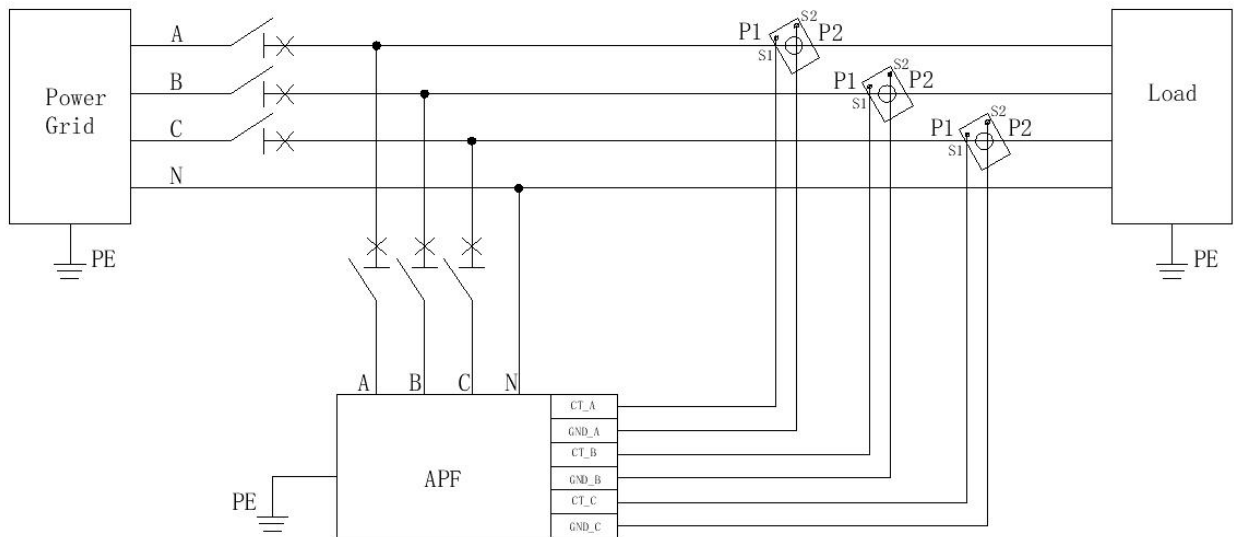
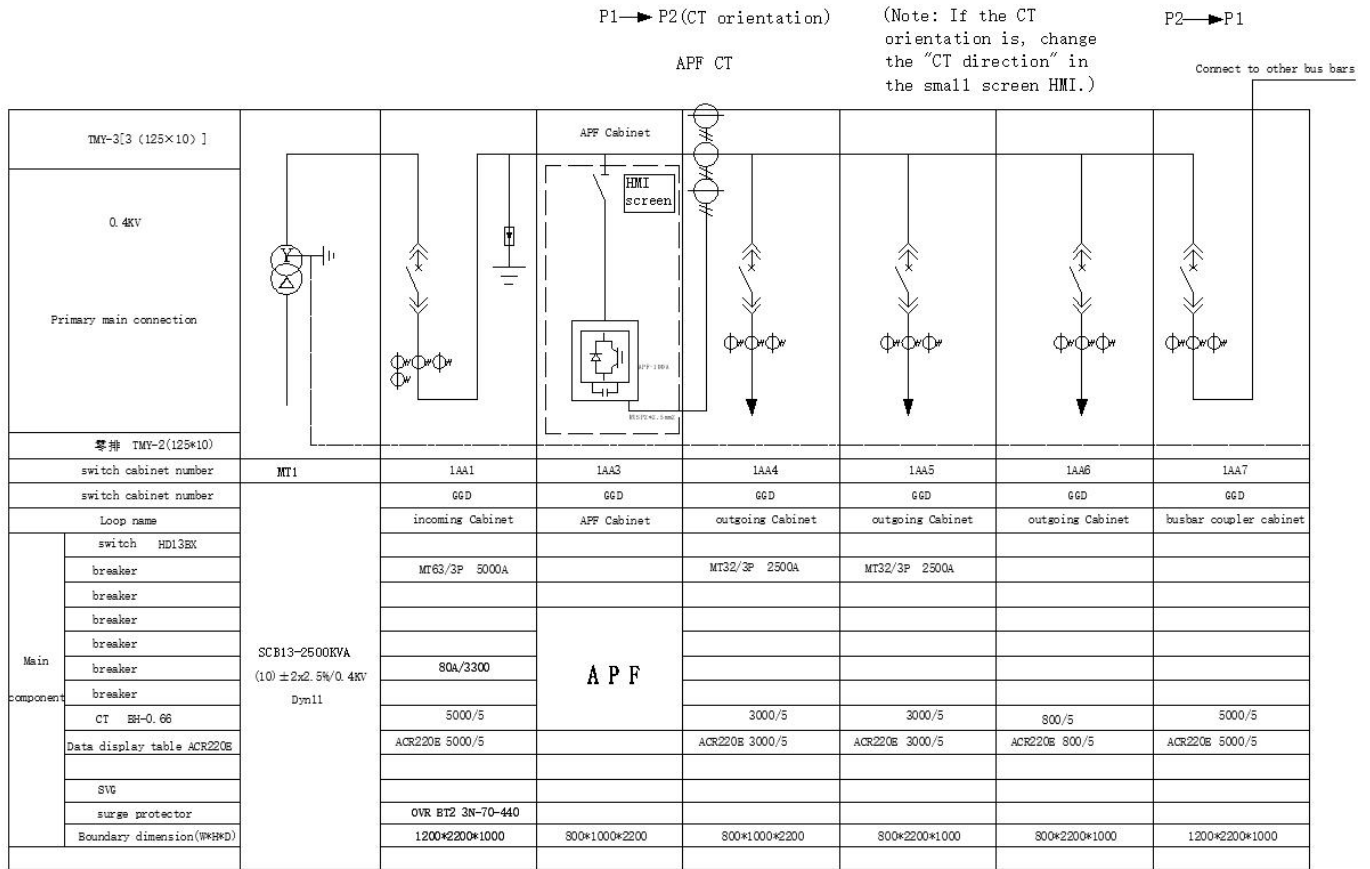

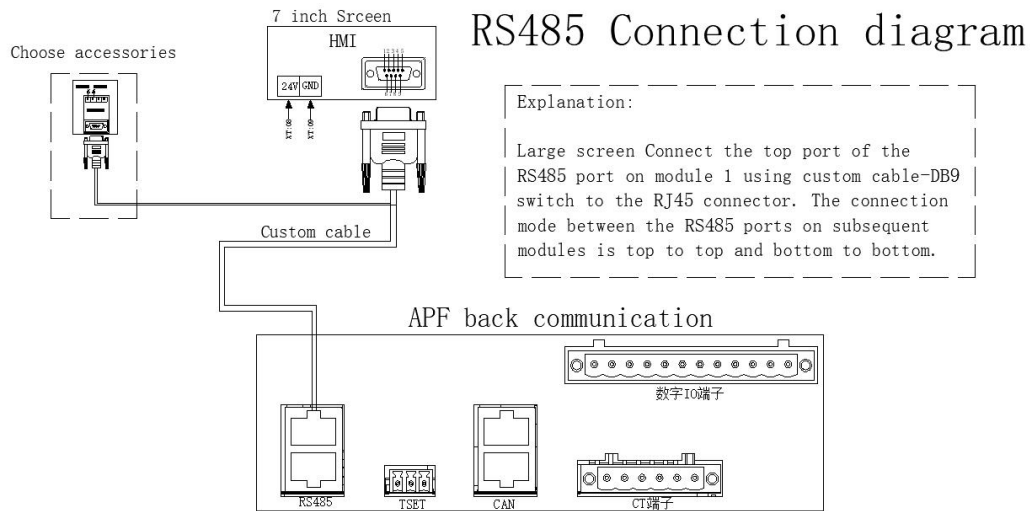

Figure 3-10 Power distribution diagram for a single machine



Note

- ◆ The circuit diagram shown here is simplified (three-phase and four-wire), please take the physical prevail;
 - ◆ **When the single machine is running, the CT wiring mode of sampling on the power side and the load side is the same;**
 - ◆ When the large screen is connected externally, DB9 special cable (our company can provide) should be used to connect the large screen to the module, and connected to the RS485 port;
- Power can be obtained from the external connection, or from the DC24V "+", - terminals on the back of the APF module;
- ◆ With background forwarding communication function is optional. Compared with the wiring without forwarding function, our company can provide more cables and adapters;
 - ◆ **See Appendix 2 for background forwarding description and interface definition.**

3.4.7 Parallel power distribution



Note

- The power connection of parallel machine is the same as that of single machine;
- When sampling on the power side, two sets of transformers with the same ratio can be installed for subtraction;
- CT side cables are recommended to be connected in series;
- ◆ Connections between parallel modules with different capacities (100A+50A) are consistent with connections between modules with the same capacity (100A+100A);
 - ◆ In parallel communication, the large screen can draw power from DC24V of one module.
- The **wiring principle of cabinet combination is the same as that of parallel**

machine. Long specifications parallel cables can be used for wiring between cabinets, which are not explained here. For details, please consult our engineer.

(1) CT load side sampling

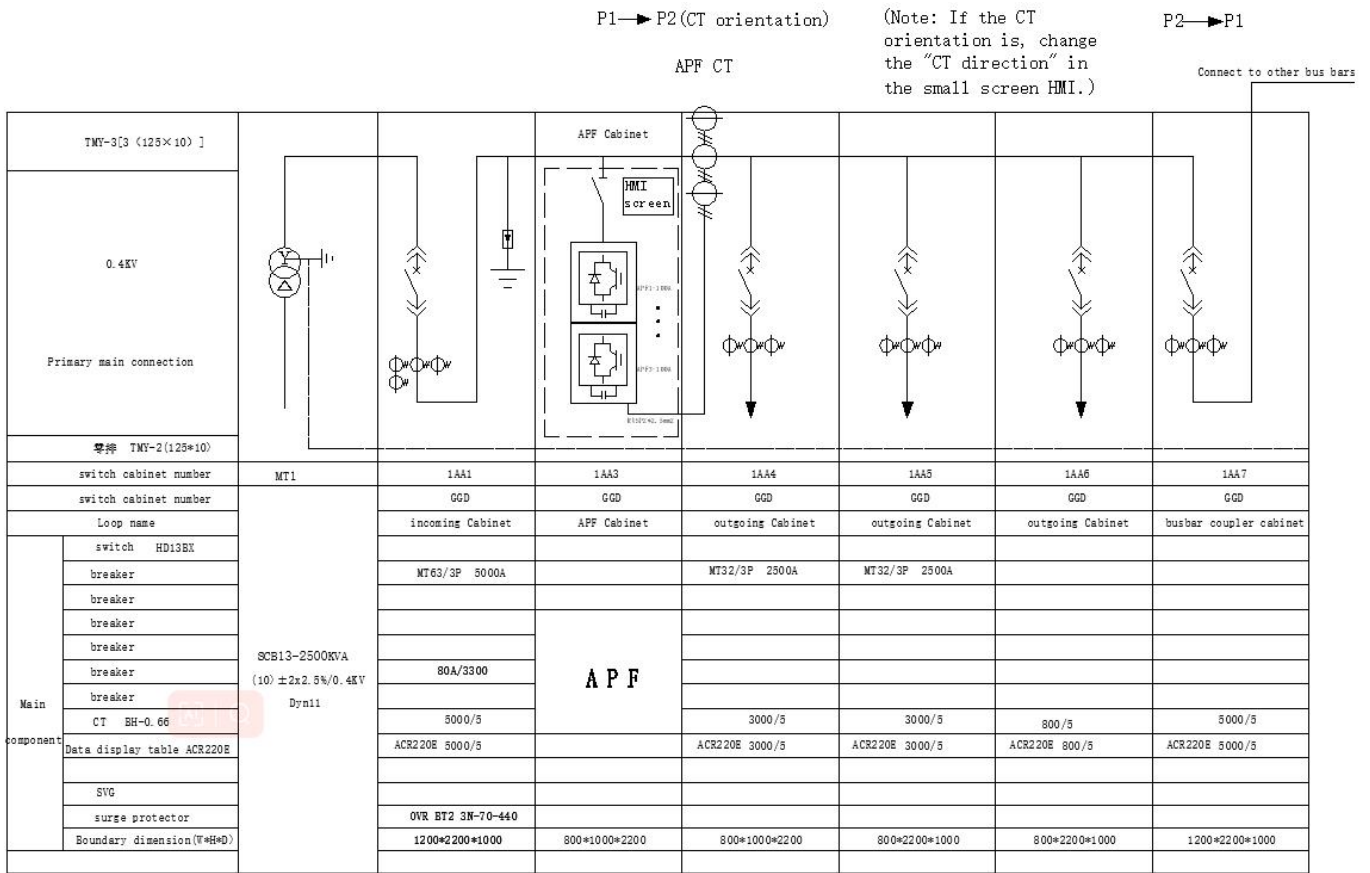

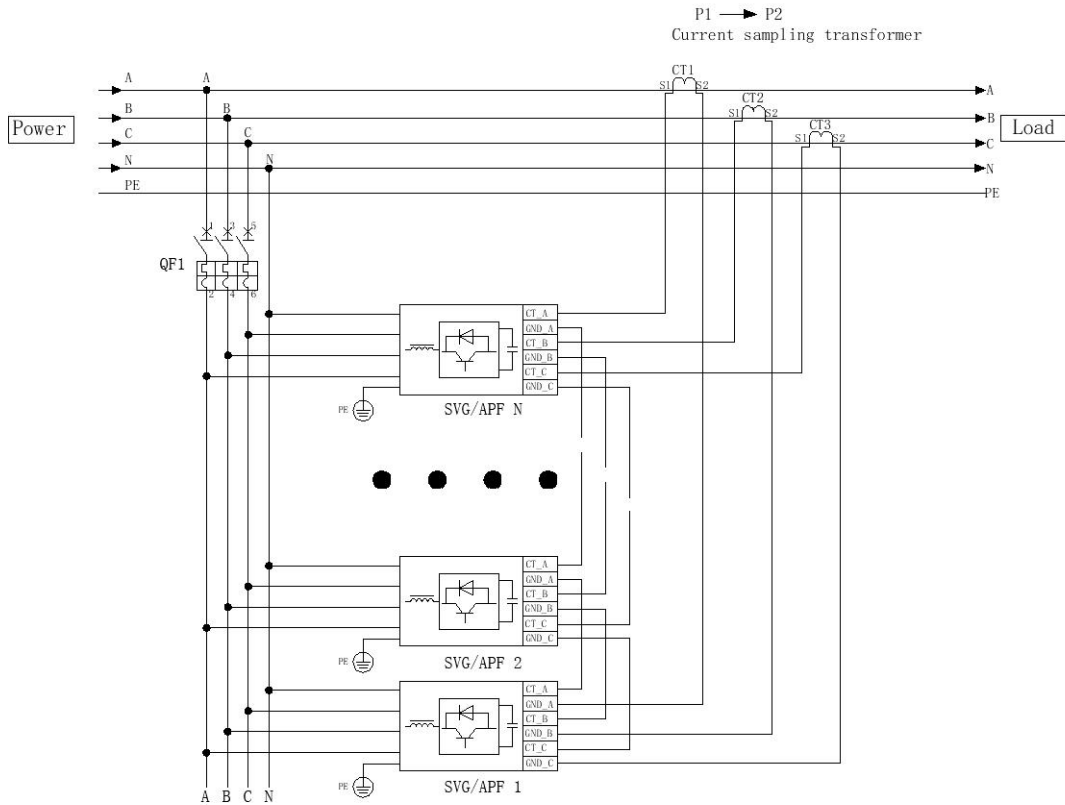
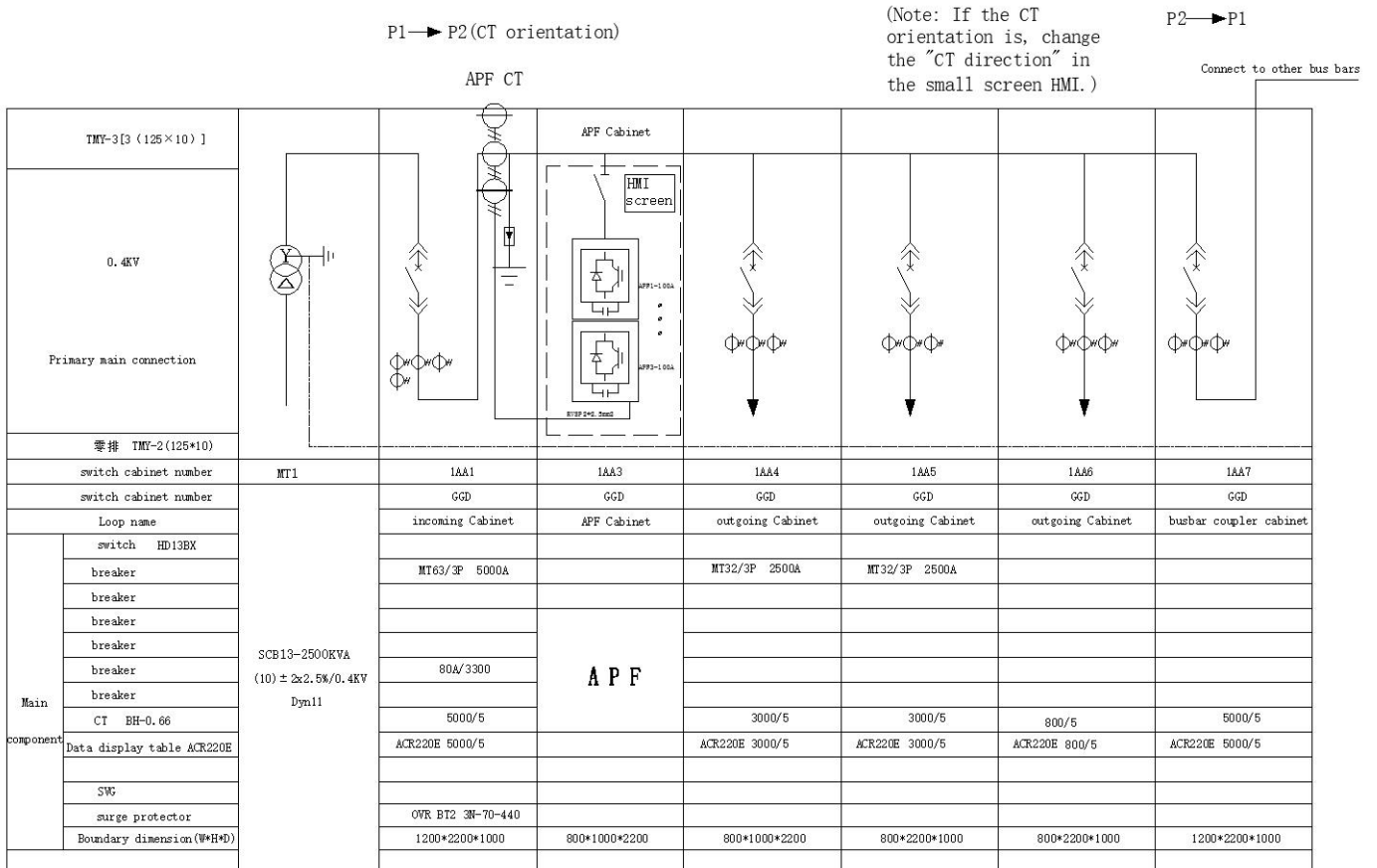

Figure 3-11 Parallel power distribution -CT load side sampling wiring diagram

(2) CT power side sampling



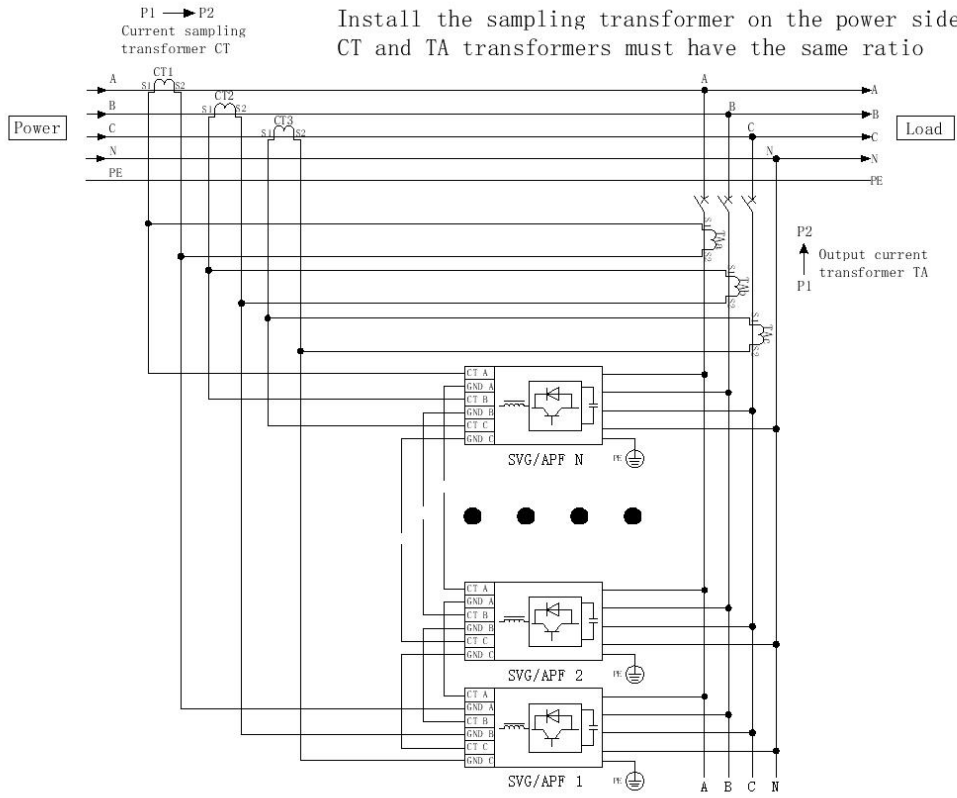

Figure 3-12 Parallel power distribution -CT power side sampling wiring diagram

(3) Communication cables

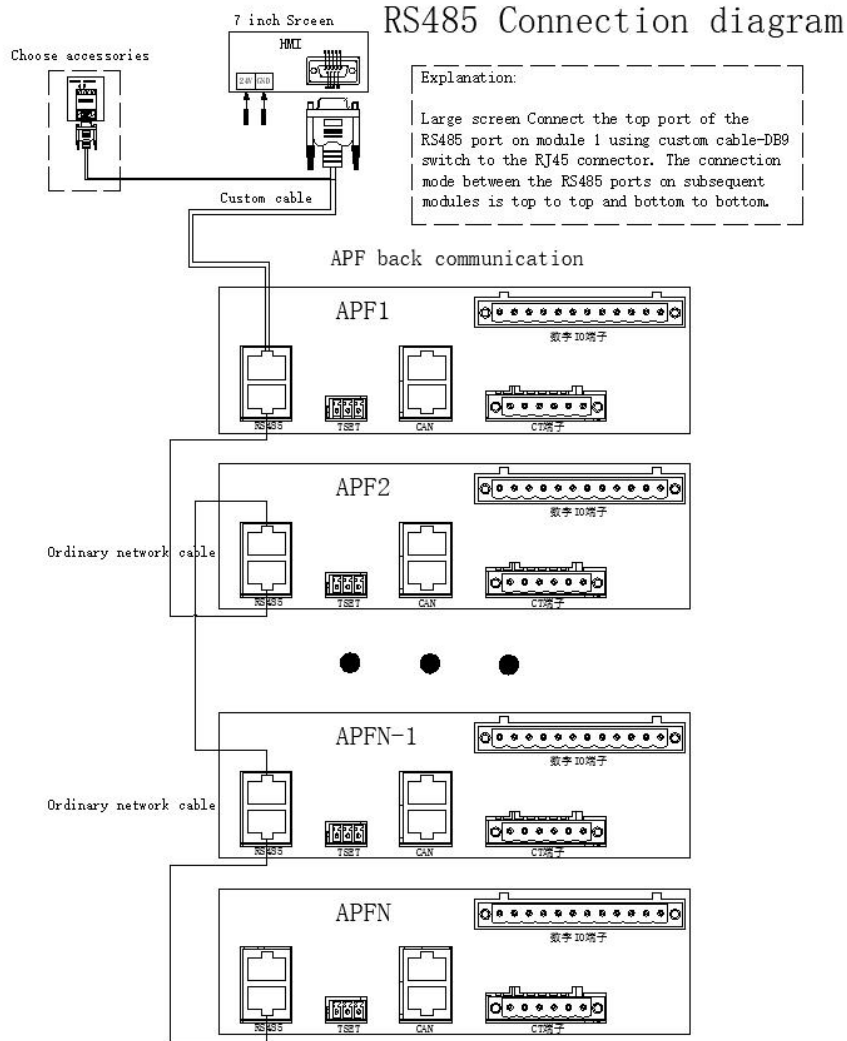



Figure 3-13 Parallel communications wiring diagram

 Note	<p>In parallel connection, the outside of the cabinet is generally equipped with a centralized monitoring screen. The large screen and the module need to be connected with DB9 special cable (our company can provide), and connected to the monitoring port of the first module;</p> <ul style="list-style-type: none"> ◆ Modules are connected with ordinary network cables, and the principle of "bottom to bottom, top to top" must be followed.
---	--

Chapter 4 Stand-alone Trial Run

4.1 Recheck

Please double check the following items before powering on for the first time:

- (1) Whether the APF equipment is securely installed on the installation column of the cabinet (wall);
- (2) Whether A/B/C/N connection is correct, whether there is leakage or mixed connection phenomenon;
- (3) A/B/C/N/PE connection is firm, no displacement or loosening occurs with hand shaking, PE connection should be firmly grounded;
- (4) need to maintain the distance between phases, phase spacing is not less than 15mm;
- (5) Use A multimeter to detect whether there is short circuit between A, B, C and N pairs of equipment;
- (6) Check whether the CT wiring is correct and whether the wiring at both ends of the terminal block is one-to-one corresponding;
- (7) Check the installation position and installation of the current transformer;
- (8) Whether the isolation switch is correctly installed and disconnected;
- (9) The APF installation environment complies with the contents described in Section 3.2;
- (10) Check whether the APF phase sequence is consistent with the grid phase sequence, and the input voltage should be positive phase sequence (A→B→C→N).

4.2 Power on the APF

After the above check is correct, close the isolation switch between the POWER supply/grid and APF, the 4.3-inch LCD LCD screen (optional) of the module or the external 7-inch large screen will light up and enter the home page, and the power /POWER indicator of the module will light up and keep on. At this time, the module is in the "standby" state. Click "Login" to enter the data page directly, and you can view the power grid voltage parameter data.

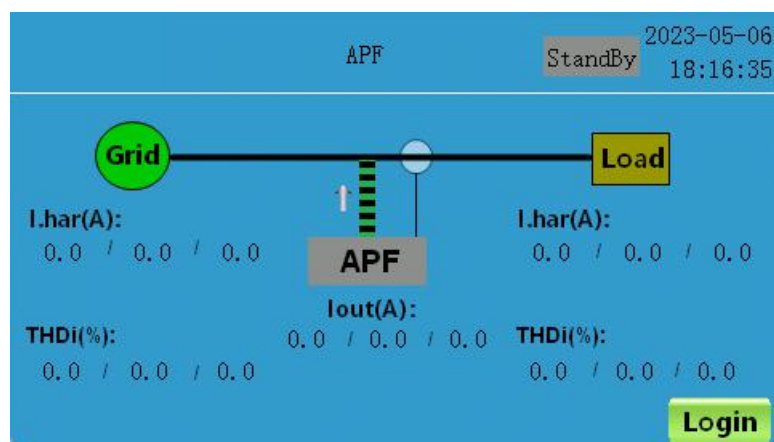

Figure 4-1 Home page

Go to the Settings page to check whether the CT ratio and the CT installation position are correct.

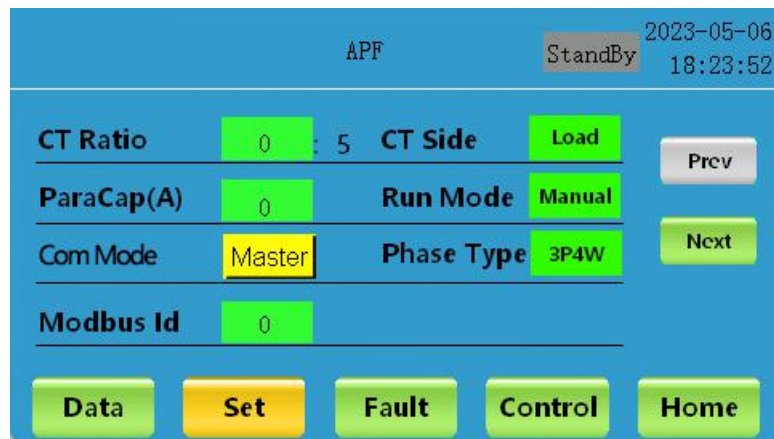

Figure 4-2 Setting operation page

After making sure that the above is correct, enter the "On/off" page, click "On" (the startup time is 30s, refer to section 6.5), and the module starts to run. At this point the RUN /RUN indicator light is on and on with the POWER /POWER indicator light.

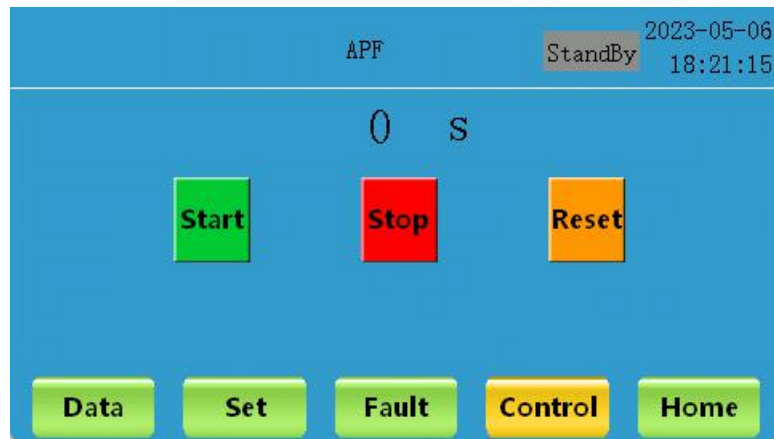

Figure 4-3 Switch on/off operation screen

After the startup is successful, click "Data" to enter the "APF" page to check whether the data of the APF is normal.

* **Please refer to Section 6 for more detailed display and operation of 4.3-inch LCD LCD.**

4.3 Power off the APF

The shutdown of an APF generally has two steps: shutdown and power off.

(1) Shut down

That is, enter the "On/Off" page through the module's 4.3-inch LCD LCD screen (optional) or the external 7-inch large screen, click "Off", and the module will enter the standby state, with the RUN /RUN indicator off but the POWER /POWER indicator on. This method only makes the module enter the standby state of low power consumption, and the system bus, auxiliary power and main loop terminals are still live.

(2) Power off

After the device is shut down and entered standby state, disconnect the isolation switch between the APF device and the power/grid, so that the operation can stop the APF device and completely power off. When the module needs to be wired or maintained, it should be turned off in a power off state.

* **Please do not directly power off the equipment in operation, this behavior will cause some damage to the equipment!**

4.4 Manual/Automatic Operation

All APF devices start in manual mode by default. In manual mode, after the module is powered on, you need to manually log in to the user interface and click Boot operation. In automatic mode, after the module is powered on, you can start up and run automatically. Users can switch to the automatic mode when the APF device is in standby state according to actual requirements. For details, please refer to Section 6.6.

Chapter 5 Parallel trial operation

Parallel module installation is usually equipped with a cabinet with a 7-inch large screen. For details about large-screen display operation, please refer to the user manual of 7-inch large screen. No details are given here.

5.1 Recheck

Before powering on the module for the first time, please check the module one by one, including the installation environment, installation position, wiring, etc. Refer to Section 4.1. In addition, check whether the communication cables between the 7-inch large screen and the first module are correct, whether the positive and negative terminals of the power cables of the large screen are mixed, and whether the cables between the two modules comply with the principle of "top to top, bottom to bottom".

5.2 Power on the APF

After the above check is correct, turn on the isolation switch between the mains and the APF, turn on the 7-inch large screen of the cabinet and the 4.3-inch LCD (optional) of the module, and the POWER /POWER indicator of the module is on and steady on. Check whether the power /POWER indicator of each parallel module is on, and the module is in standby state.

Log in for 7-inch large-screen advanced users and enter the home page to check whether data parameters such as power grid side, output side and load side of each parallel module are normal.

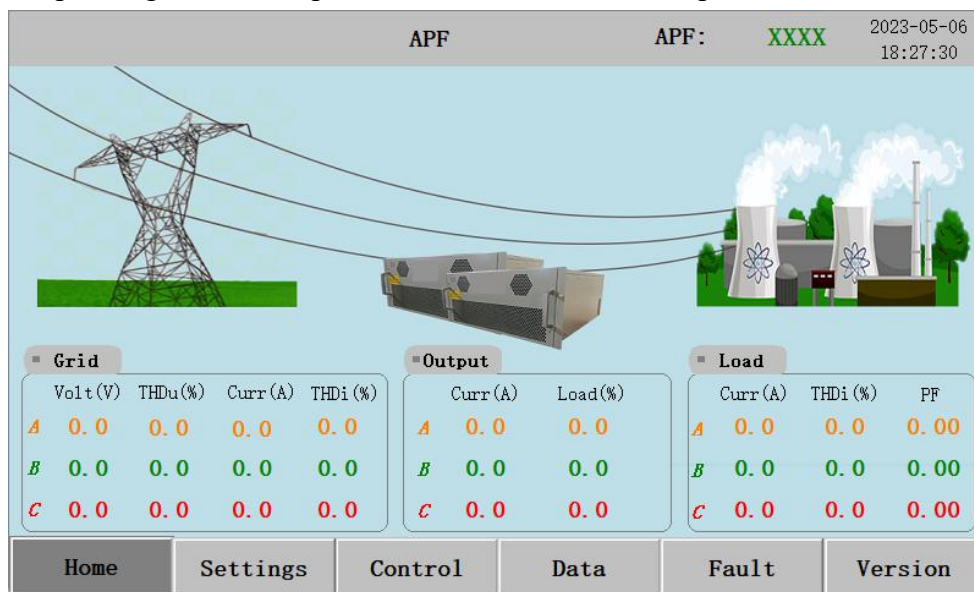

Figure 5-1 Front page of the large screen

Enter the setting page again to check whether the parameters of CT ratio, CT position, CT direction, operation mode, parallel capacity and other Settings are correct. At this time, switch the parallel module through the large screen, and observe whether the data of each module is normal and consistent with the set parameters. If not, please check the connection and modify the parameters through the large-screen operation Settings (please operate under the guidance of engineers).

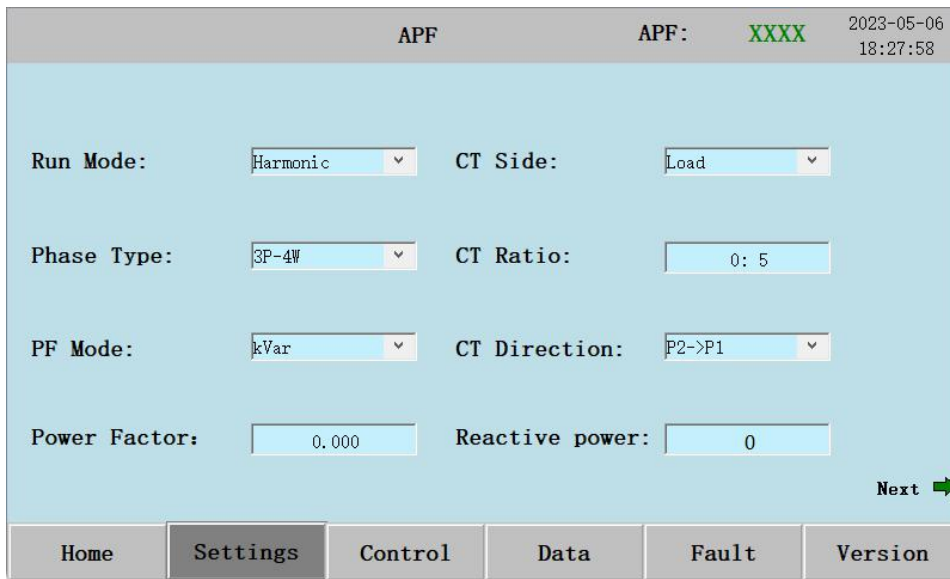

Figure 5-2 Large screen Settings screen

After making sure that the parameters are correct, enter the "Control" page, click "Power on" (power on time is 30s), and the module starts to run. The RUN /RUN indicator light of each parallel machine module is on and on together with the POWER /POWER indicator light. At this time, you can check whether the run /RUN indicator light of each module is on. If you find any module with the indicator light is not on, you can check whether the communication cable of the parallel machine is correctly connected.

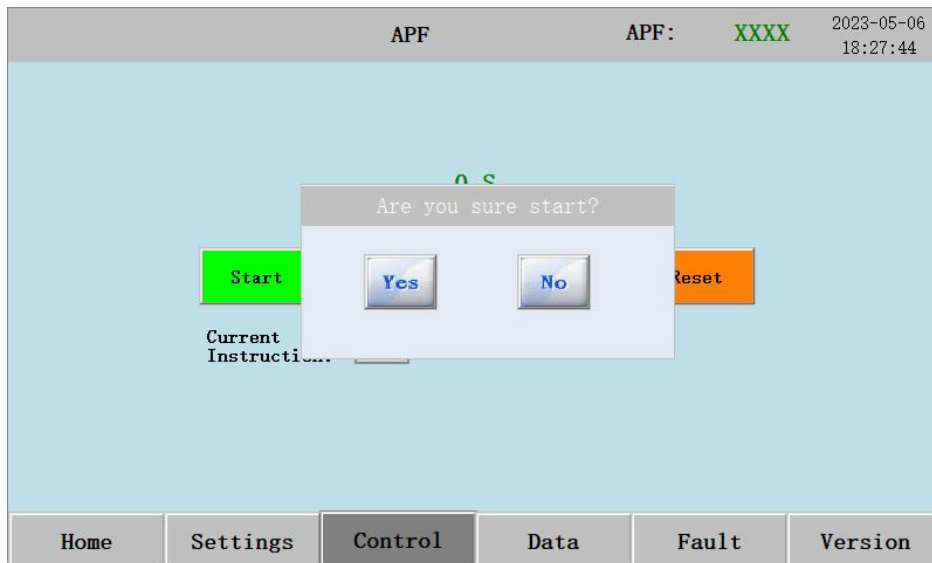

Figure 5-3 Large screen control screen

After the device is powered on successfully, click Data to check whether the real-time data of Basic, Power, and Harmonic are normal one by one.

5.3 Power off the APF

There are two steps to shut down the parallel APF module: shutdown and power off.

(1) Shut down

That is, through the 7-inch screen outside the module connected to the cabinet, enter the "On/Off" page, click "Off", all parallel modules enter the standby state, the RUN /RUN indicator is off, but the POWER /POWER indicator is still on. This method only makes the module enter the standby state of low

power consumption, and the system bus, auxiliary power and main loop terminals are still live.

(2) Power off

After the device is shut down and entered standby state, disconnect the isolation switch between each APF device and the power/grid. Only in this way can the APF device stop running and completely power off. When the module needs to be connected or maintained, it should be left in the power off state.

*** Please do not directly power off the equipment in operation, this behavior will cause some damage to the equipment!**

5.4 Manual/Automatic operation

All APF devices start in manual mode by default. In manual mode, you need to manually log in to the user interface and click Power on after the module is powered on. In automatic mode, you can start up and run automatically after the module is powered on. Users can switch to the automatic mode when the APF device is in standby state according to actual requirements. For specific operation, please refer to the user manual with a 7-inch large screen. No additional explanation is provided here.

Chapter 6 Menu with 4.3-inch Screen

The front panel of the module will have a 4.3-inch LCD screen (optional), which provides a user-friendly user interface.

- (1) Users can view the status and information of power grid, load and APF module through the 4.3-inch screen;
- (2) The user can carry out all the operation commands in the menu of the module through the menu button provided on the page;
- (3) It is conducive to monitor, check and eliminate the faults occurring in the APF module;
- (4) Can display the APF system version and monitoring software system version;
- (5) Click the "login" button to enter the user interface, no need to enter the password, convenient and fast;
- (6) The screen display page can be customized according to the needs of the display, logo, special model, name and change background and so on.

6.1 LCD Home page

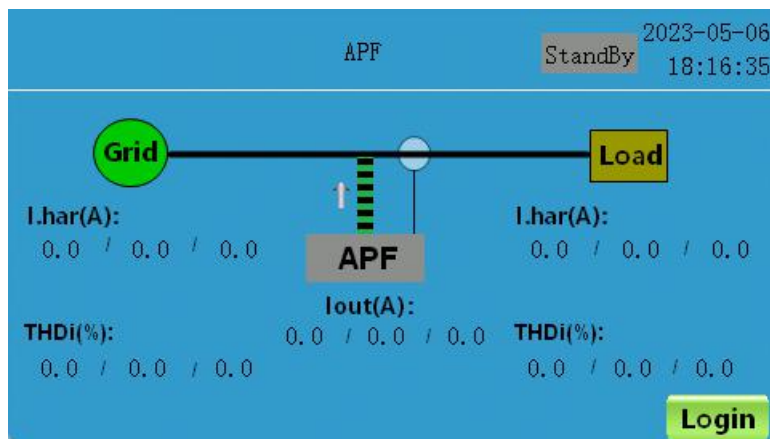

Figure 6-1 Home page

- ◆ The screen will light up automatically when the screen is powered on, and enter the home page automatically after the startup page, no second operation is required;
- ◆ You can view the data of power grid, load and APF current on the home page;
- ◆ You can view the APF device model and status (standby/running) on any interface of the display screen.

6.2 Data page

6.2.1 Power Grid Data

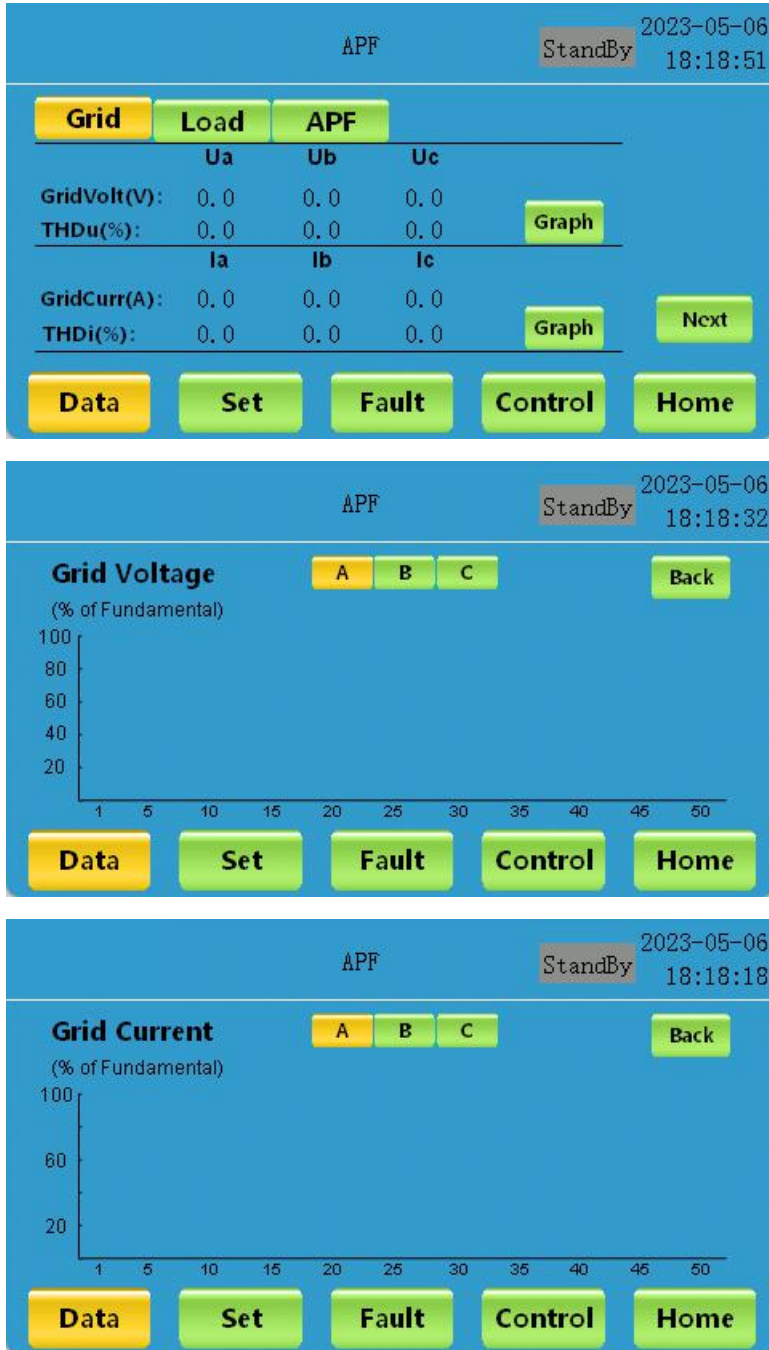

Figure 6-2 Data page - Power grid

The Grid data page contains two pages:

- ◆ On the first page, you can view the data of power grid: power grid voltage value, power grid voltage bar graph and voltage distortion rate THDu, power grid current, power grid current bar graph and current distortion rate THDi;
- ◆ On the second page, you can view the power factor, active power, reactive power, apparent power and other values of the three-phase power grid.

6.2.2 Load Data

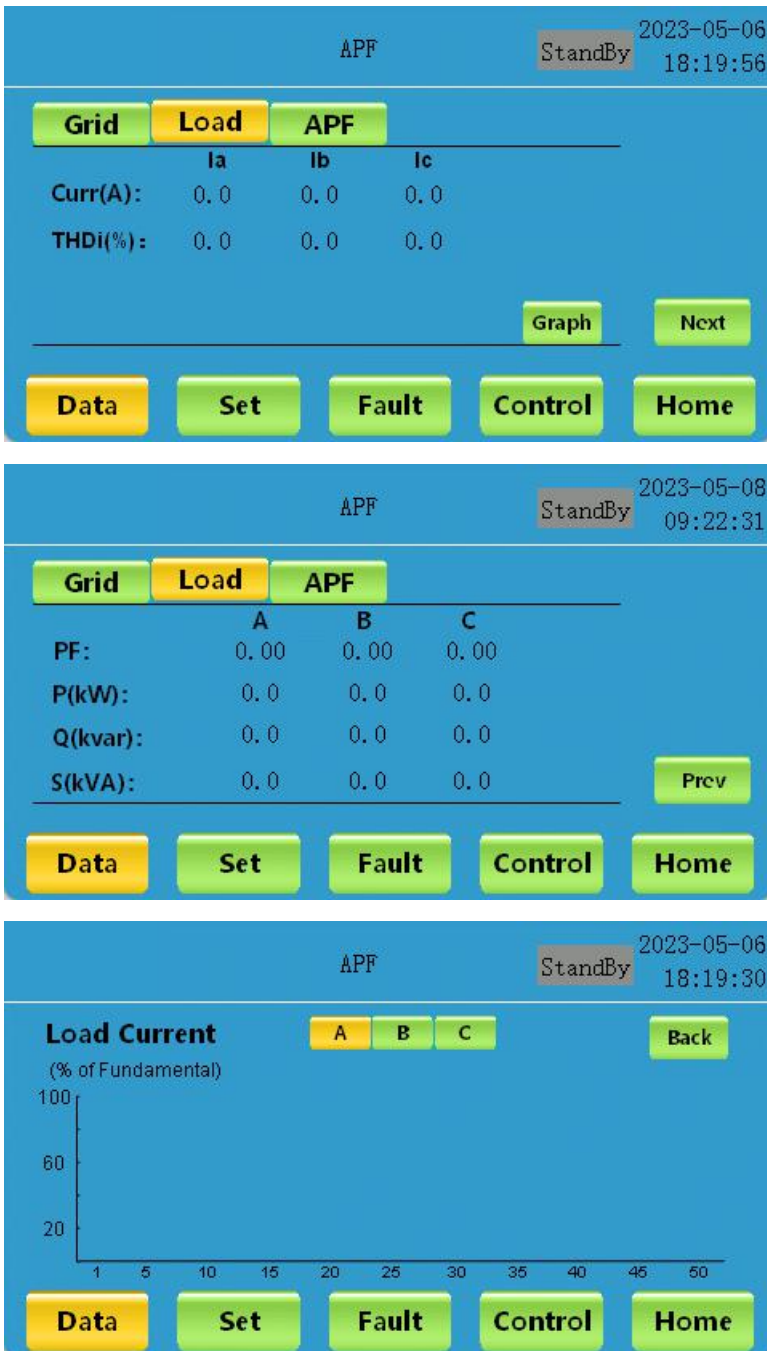

Figure 6-3 Data page - Load

The load data page contains two pages:

- ◆ In the first page can check the load three-phase current, current distortion rate THDi and load current bar chart;
- ◆ In the second page can view the load three-phase power factor, active power, reactive power, apparent power and other values.

6.2.3 APF Data

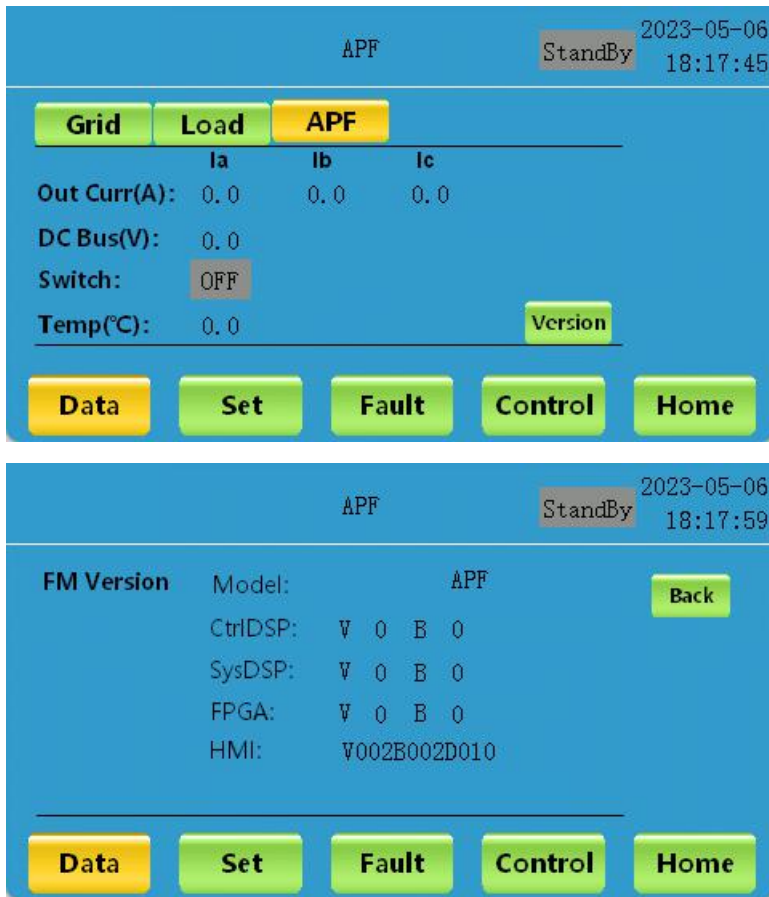

Figure 6-4 Data page -APF

The APF data page contains two pages:

- ◆ In the first page, you can view the data of APF equipment: output current, bus voltage, contactor state, system temperature;
- ◆ On the second page, you can view the firmware version information number of the APF device, such as the model, main DSP version, auxiliary DSP version, FPGA version and HMI version.

6.3 Setup page

The Settings page can be accessed via the "Settings" button on the screen, and there are five pages.

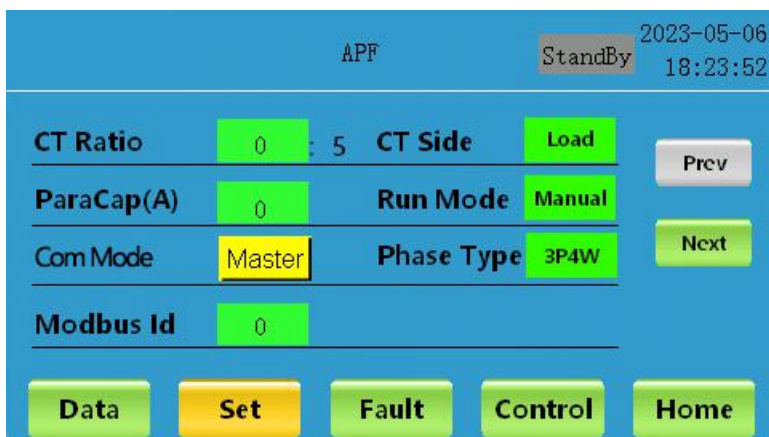

- ◆ On the first page, you can view and set CT ratio, CT position, parallel capacity, starting mode, master/slave, wiring mode, ModBus address;
- ◆ On the second page, you can view the Settings of power grid overvoltage point, power grid undervoltage point, power grid underfrequency point, power grid underfrequency point, zero line overcurrent point, power grid overcurrent point, monitoring address, resonance overcurrent point and other data.



Figure 6-5 Settings page

Page 3 and page 4 for harmonic compensation Settings:

- ◆ In the third page can operate to open and close 1~49 harmonic compensation (odd times);
- ◆ In the fourth page, you can operate to open and close 2~50 harmonic compensation (even times).
- ◆ On the fifth page, you can view and set the grid phase sequence, power factor, allowed phase sequence, reactive power set mode, serial port 1 baud rate, serial port 3 baud rate, APF ratio, parallel number and other data;
- ◆ Curing parameters: save the set parameters.

6.4 Fault page



Figure 6-6 Fault page

The fault page can be accessed by the "Fault key" on the screen. There are five pages in total.

- ◆ In the first three pages, you can check EPO fault, IGBT fault, power grid fault, pre-charging bus fault, communication fault.... Whether it happens, so as to judge whether the machine is in normal operation;
- ◆ When the fault /FAULTA indicator light is red, read the fault page or record to locate the fault type more quickly.

- ◆ Click the "History" button to enter the fourth page, where you can view the fault information in the history of the APF equipment, including date, time and fault information;
- ◆ Click "Clear Record" to delete the fault information record.

6.5 Switch page

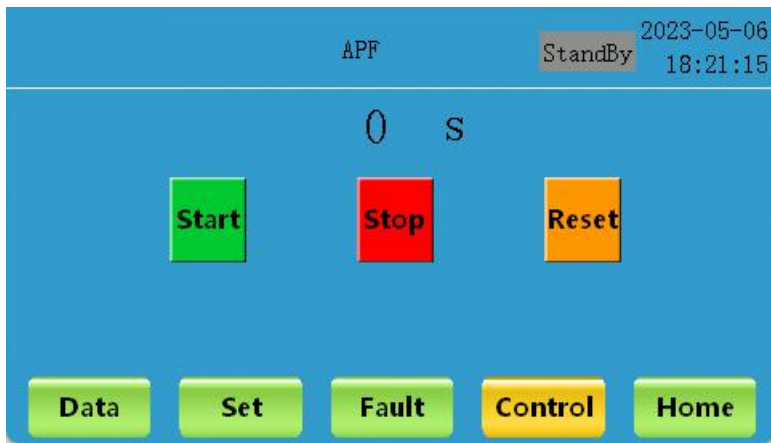



Figure 6-7 On/off page

- ◆ Click the "Power on" button, the number on the top of the screen changes from 0s to 30s, the startup time is over, the APF device gives a soft "bang" sound, indicating that the device has been successfully started, and the device enters the running state;
- ◆ Click the "Power Off" button, and the APF will enter the standby state of low power consumption;
- ◆ Click "Reset" to eliminate the fault.

6.6 Example of operation Settings

The user can perform all the operation commands in the menu for the module through the menu button provided on the page, and operate the Settings in this example section.

 Note	<ul style="list-style-type: none"> ◆ All setting operations must be carried out in the standby state, after setting the need to cure parameters, so that the setting results will take effect; ◆ All the parameters have been set when leaving the factory. If the parameters need to be modified due to the actual situation on the site, please contact professional and technical personnel in time and operate under the guidance of professional and technical personnel. The company will not be responsible for any equipment failure or damage caused by modifying the parameters without authorization.
---	---

6.6.1 Setting CT ratio

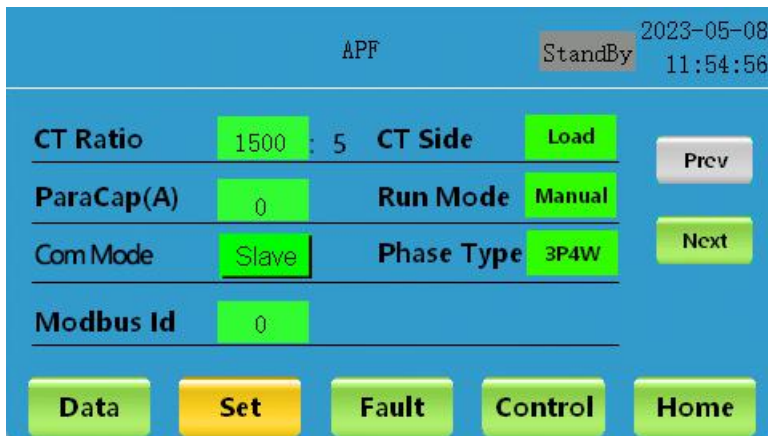
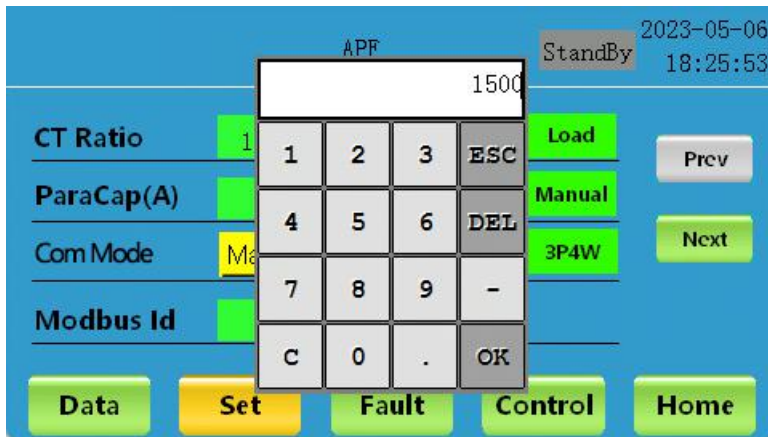
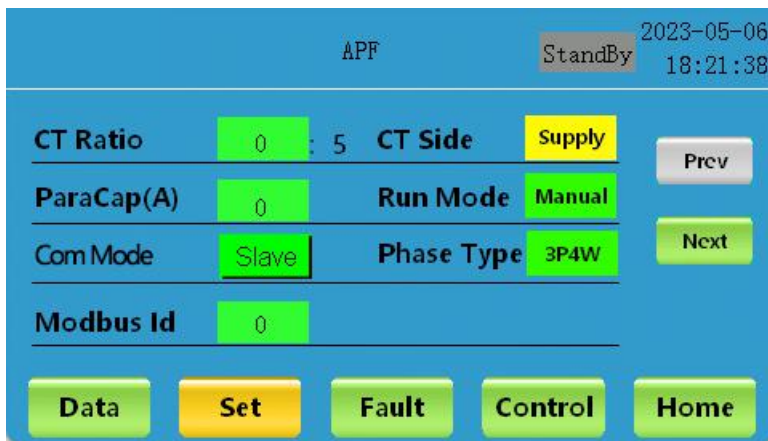

- ◆ Find "CT ratio" on the setting page, click the green button to call out the keyboard, enter the correct and reasonable ratio value according to the actual situation on site, and click "OK" to confirm.

Figure 6-8 Setting CT ratio

6.6.2 Setting the CT Position

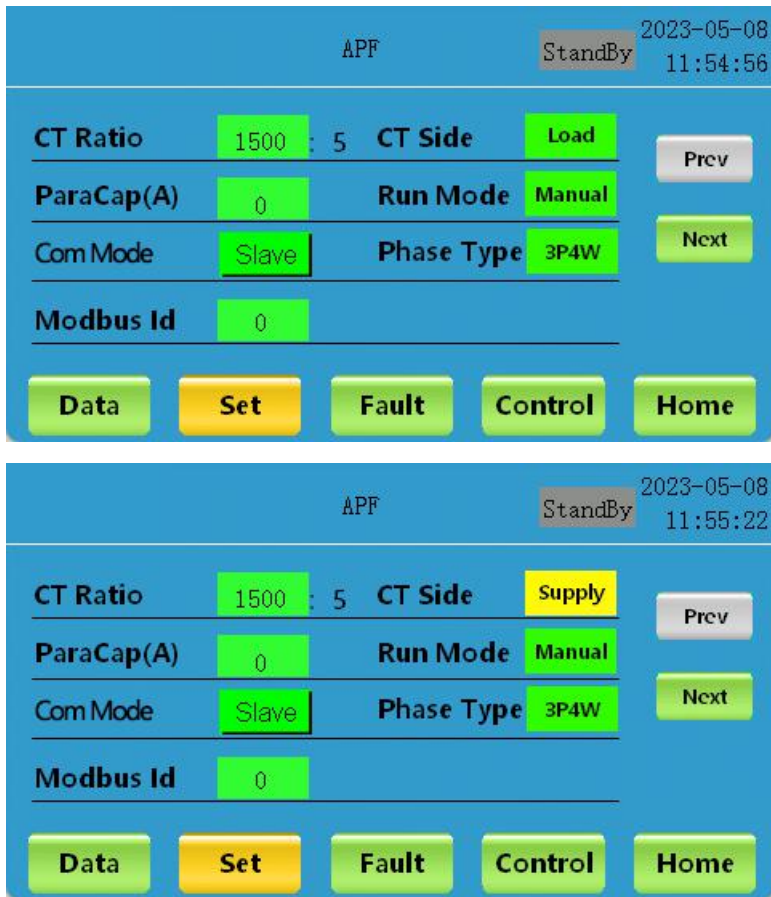
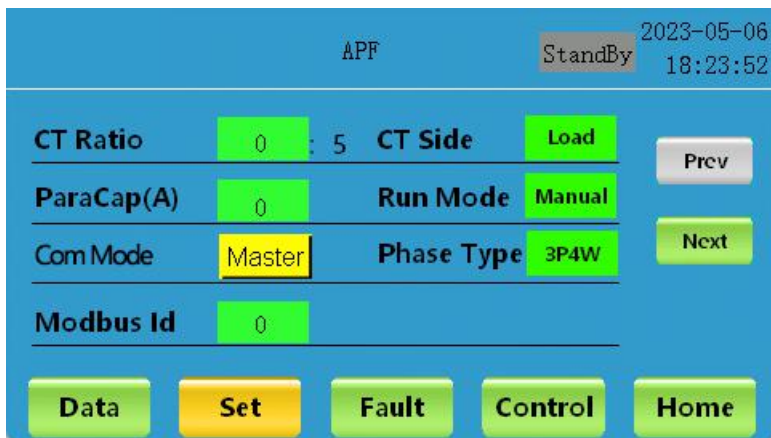

Figure 6-9 Setting the CT position

6.6.3 Setting Boot Mode



The default setting of CT position is "load side";

- ◆ If the CT is installed on the power side in the actual situation, the CT position should be switched from "load side" to "power side";

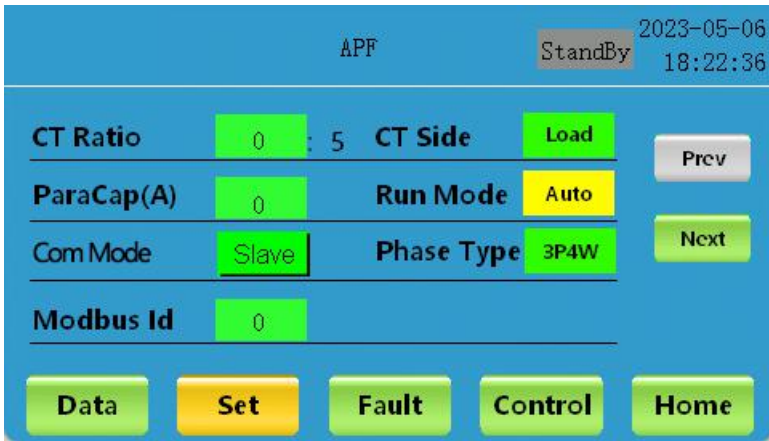

Figure 6-10 Setting the boot mode

6.6.4 Setting harmonic compensation times



- ◆ In manual mode, after the module is powered on, it needs to be started up manually;

- ◆ In automatic mode, after the module is powered on, it can automatically start up and run without secondary operation;

The startup mode is set to manual mode by default;

You can switch to automatic mode by clicking the standby mode according to the actual demand.

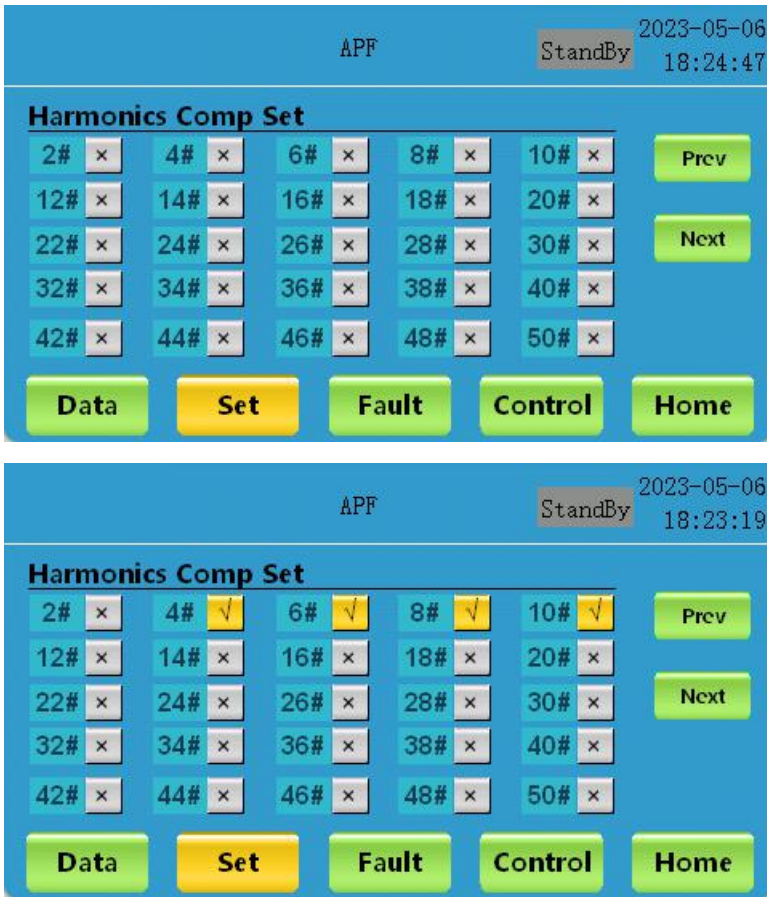

Figure 6-11 Setting the harmonic compensation times

- ◆ The filter range of APF equipment is 2~50 times optional;
- ◆ For example, if 3~10 harmonics need to be filtered, enter the third and fourth page of the setting page, and check 3#~10#.

6.6.5 Setting the phase sequence

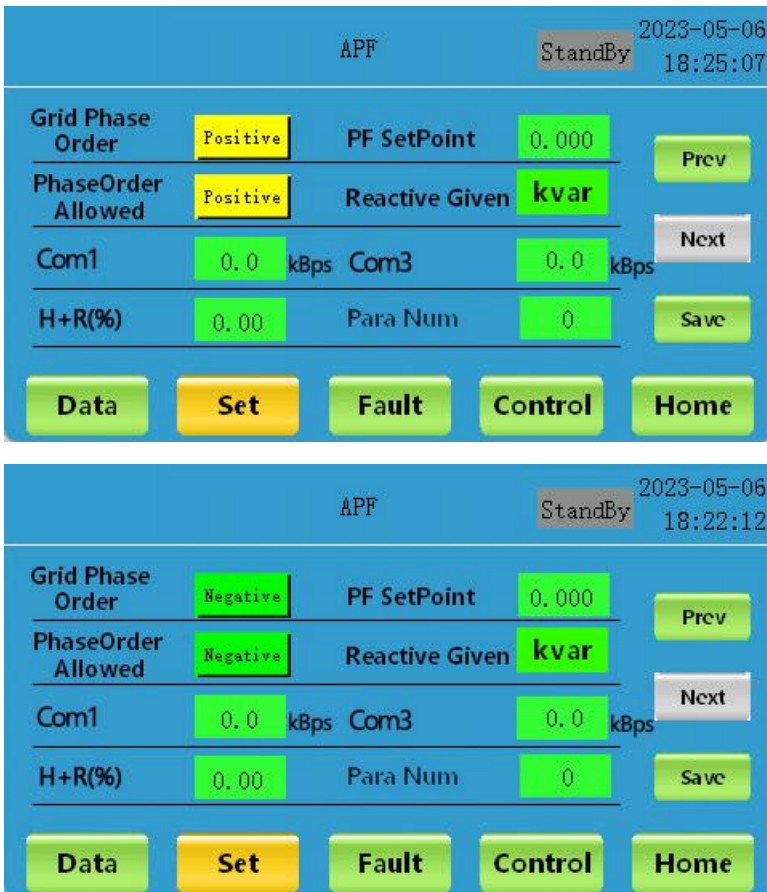

Figure 6-12 Setting the grid phase sequence

- ◆ APF equipment can automatically identify the grid phase sequence as "positive" or "negative", allowing the factory default setting of phase sequence to be positive. When the grid phase sequence is displayed as "negative sequence", you need to manually switch the allowed phase sequence to "negative sequence".

Chapter 7 Human-computer interaction interface

The LCD 7-inch HMI is installed on the front of the active filter cabinet door and is available in two different sizes. Users can monitor, read, set and modify the APF parameter data of the active filter cabinet through HMI. It is an optional item. Please contact our professional and technical personnel for detailed operation information of the 7 inch HMI display!

7 inch HMI two different hole sizes are 215*152mm and 192*138mm respectively. By default, a large screen with a hole size of 215*152mm is selected. If a large screen with a hole size of 192*138mm is required, please make remarks in advance.

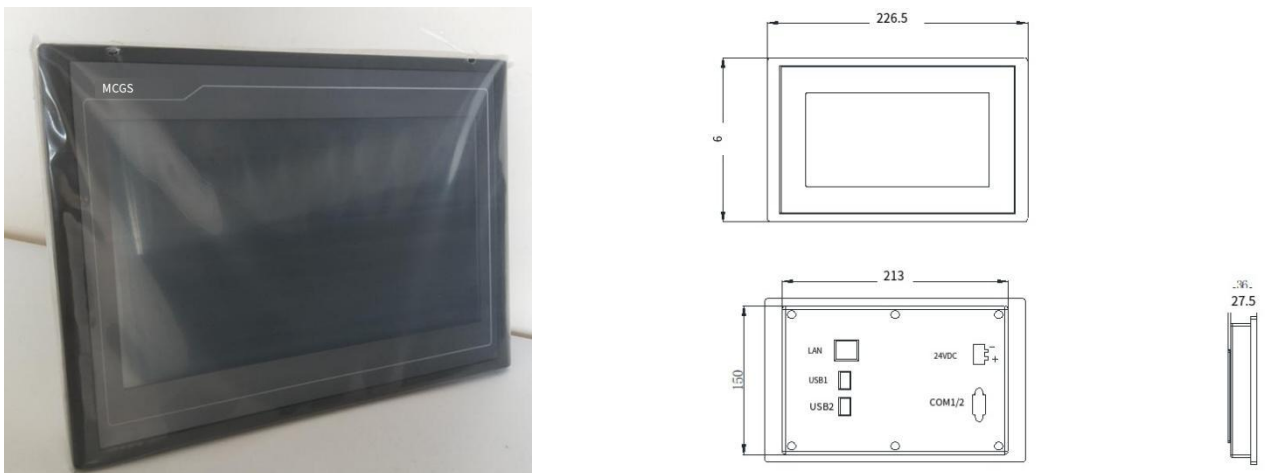



Figure 7-1 A 215 x 152 screen with a large hole

Product Features		External interface	
LCD screen	7 "TFT	Serial interface	COM1(RS232), COM2(RS485), extensible (COM3,COM4)
Backlight	LED	USB port	1 master 1 slave
Input voltage	DC: 24V±20%	CAN interface	expandability
Rated power	5W	Ethernet port	Unsupported
Certification		Environmental conditions	
Product certification	CE/FCC	Storage temperature	-10 to 60 ° C
Level of protection	IP65 front panel	Operating temperature	0 to 45°C
Electromagnetic compatibility	Industrial grade III	Working humidity	5% to 95%
		Product specifications	
		Housing materials	Industrial plastics
		Panel size	226.5 by 163 (mm)
		Hole size	215*152 (mm)

*** In addition, we can provide a 10-inch HMI large screen. It is recommended that the opening size of the cabinet be 261*180mm.**

Chapter 8 Care and Maintenance

In order to ensure the normal and safe operation of APF equipment, we recommend regular maintenance of equipment.

 Danger	◆ Beware of electric shock, pay attention to protection!
---	--

8.1 Pre-maintenance attention

- (1) The APF equipment is running with strong electricity. For safety, maintenance personnel should not touch any part of the equipment when the equipment is running;
- (2) Because the APF equipment bus has a large number of capacitors, the repair and maintenance work must be carried out 15 minutes after the power failure;
- (3) After the power is disconnected, a warning sign should be set at the disconnected place to prevent someone from powering on during maintenance;
- (4) In order to avoid accident risks, maintenance personnel should wear insulation equipment during maintenance;
- (5) Only personnel with professional and technical qualifications can maintain the APF equipment.

8.2 Maintenance content and cycle

Maintenance Items	Maintenance content	Recommended hours
Routine inspection	The input, output voltage, current and running state of the APF equipment should be monitored in real time to observe whether it is in the normal range;	Every day
	Check to see if the inlet and outlet are clear;	
	Read the temperature inside the APF device to see if it is in the normal range.	
Status Check	Check the appearance of the APF equipment for breakage and rust;	Half a month
	Listen to whether there is abnormal sound when the APF equipment is running, smell whether there is bad smell;	
	Check whether the ambient humidity, temperature, dust and ventilation conditions around the equipment meet the requirements.	
Checking Cables	Check cables, terminals for damage;	Three months
	Whether the main loop wiring, ground wiring, communication wiring, etc. are connected reliably;	

	Check whether there are signs of aging and burning at the wiring bolts, and shake them with your hand to confirm whether they are tightened.	
--	--	--

8.3 Maintenance steps

Step 1: Examine your surroundings

(1) Use professional equipment to test the temperature and humidity of your environment to make sure it is within normal limits.

(2) Remove debris from around the module and keep it dry.

Step 2: Turn it off

(1) Disconnect the isolation switch, APF power off;

(2) Wait at least 15 minutes for the capacitor in the module to discharge completely.

Step 3: Clean the device

(1) Inspect the surface of the equipment for damage and missing;

(2) Visual inspection cable deformation, damage;

(3) Clean the dust and debris on the surface of the equipment, and pay attention to clean the position of the inlet and outlet for foreign matter blockage.

Step 4: Check the isolation switch

(1) Check whether the isolation switch is aging and damaged.

Step 5: Check the mechanical installation/electrical connection

(1) Check whether all the screws at the installation of the mechanical connection are firm, and clean up the dust on them;

(2) Check whether the electrical connection is firm, and the cable can be properly reinforced or replaced.

Step 6: Other abnormalities

(1) For example, if there is a foreign body inside the module or the internal cable is damaged, please contact the technical personnel of the manufacturer in time.

Step 7: Restart the device

(1) Restore all cable connections and check them;

(2) Close the isolation switch and start the device;

(3) Check the parameters;

(4) Start up and run.

Chapter 9 Common troubleshooting

Serial number	Fault name	What to do
1	EPO failure	Check whether the emergency stop switch button is pressed down, reset the button switch and then click the reset switch on the small screen or the large screen to remove the fault; If not, please contact the manufacturer's professional and technical personnel!
2	IGBT hardware overstreams	Reset or restart the boot, if not solved please contact the manufacturer professional technical personnel!
3	Bus hardware overvoltages	Click the small screen data interface to check the voltage of the APF data bus. The standby bus voltage of the normal module is about 650. If it exceeds the range, please contact the professional and technical personnel of the manufacturer!
4	Module hardware overstreams	Check whether the CT installation direction is consistent with the setting, and whether the CT secondary wiring is reversed. If not solved, please contact the professional and technical personnel of the manufacturer!
5	Auxiliary power failure	This fault please contact the manufacturer professional and technical personnel to solve!
6	Fan failure	Check whether the fan is in normal operation. If the fan is not in operation, replace the fan. If it is in normal operation, click reset and start again.
7	Board connection failure	Click reset or restart the boot, if not solved please contact the manufacturer professional technical personnel!
8	Damaged fuse	Click reset or restart the boot, if not solved please contact the manufacturer professional technical personnel!
9	The power module is overheated	Check whether the ambient temperature is too high, and whether the inlet and outlet of the system are smooth. If everything is normal, you can reset it and start it again. If it is not solved, please contact the professional and technical personnel of the manufacturer!

10	Voltage A/AB overvoltage	Confirm whether the input voltage is normal, if not solved please contact the manufacturer professional and technical personnel!
11	Voltage B/BC overvoltage	Confirm whether the input voltage is normal, if not solved please contact the manufacturer professional and technical personnel!
12	Voltage A/AC overvoltage	Confirm whether the input voltage is normal, if not solved please contact the manufacturer professional and technical personnel!
13	Voltage A/AB undervoltage	Confirm whether the input voltage is normal, if not solved please contact the manufacturer professional and technical personnel!
14	Voltage B/BC undervoltage	Confirm whether the input voltage is normal, if not solved please contact the manufacturer professional and technical personnel!
15	Voltage C/CA undervoltage	Confirm whether the input voltage is normal, if not solved please contact the manufacturer professional and technical personnel!
16	Grid overfrequency	Check whether the input voltage frequency is in the range of 40.5~62.5Hz. If it is in this range, it is a false alarm for the system. Please contact professional technical personnel of the manufacturer.
17	Grid underfrequency	Check whether the input voltage frequency is in the range of 40.5~62.5Hz. If it is in this range, it is a false alarm for the system. Please contact professional technical personnel of the manufacturer.
18	The grid phase sequence is reversed	Check the input grid phase sequence and allowed phase sequence is correct, if not solved please contact the manufacturer professional technical personnel!
19	A phase pass	Reduce the input current value of the grid, if not solved, please contact the manufacturer's professional and technical personnel!
20	B phase overflow	Reduce the grid input current value, if not solved, please contact the manufacturer professional and technical personnel!
21	C phase overflow	Reduce the grid input current value, if not solved, please contact the manufacturer professional and technical personnel!
22	Overvoltage of the pre-charged bus	Click reset shutdown, disconnect the circuit and adjust the bus to take power, if not solved please contact the manufacturer professional and technical personnel!
23	Precharge bus undervoltage	Click reset shutdown, disconnect the circuit and adjust the bus to take power, if not solved please contact the manufacturer professional and

		technical personnel!
24	Do not control the undervoltage of the rectifier bus	Click reset shutdown, disconnect the circuit and restart the circuit switch, if not solved please contact the manufacturer professional and technical personnel!
25	Run the bus over voltage	Confirm whether the bus voltage is normal, if not solved please contact the manufacturer professional and technical personnel!
26	Run the bus under voltage	Confirm whether the bus voltage is normal, if not solved please contact the manufacturer professional and technical personnel!
27	The positive and negative bus bars are not balanced	Check whether the N line is connected, if not solved please contact the manufacturer professional technical personnel!
28	Error in background communication protocol	Check whether the connection between the module and the large screen is normal. If it is not solved, please contact the professional and technical personnel of the manufacturer!
29	EEPROM failure	Click reset to restart the boot, if not solved please contact the manufacturer professional technical personnel!
30	Auxiliary DSP fault	Click reset to restart the boot, if not solved please contact the manufacturer professional technical personnel!
31	Synchronous phase locking between DSPS	Click reset to restart the boot, if not solved please contact the manufacturer professional technical personnel!
32	System resonance	Click reset to restart the boot, if not solved please contact the manufacturer professional and technical personnel!
33	The module does not communicate with the large screen	Check whether the communication cable is properly connected, whether the positive and negative poles of the 24V power cable are reversed, and whether the wiring screws are tightened. If not solved, please contact the professional and technical personnel of the manufacturer!

*** Here is only a list of common faults and solutions, in case of other unknown faults, please contact professional manufacturers professional and technical personnel in time!**

Appendix

1. 400V-150A/200A and 690V-100A appearance schematic

The 400V-150A/200A and 690V-100A modules have the same exterior style except for their sizes.

(1) Rack type

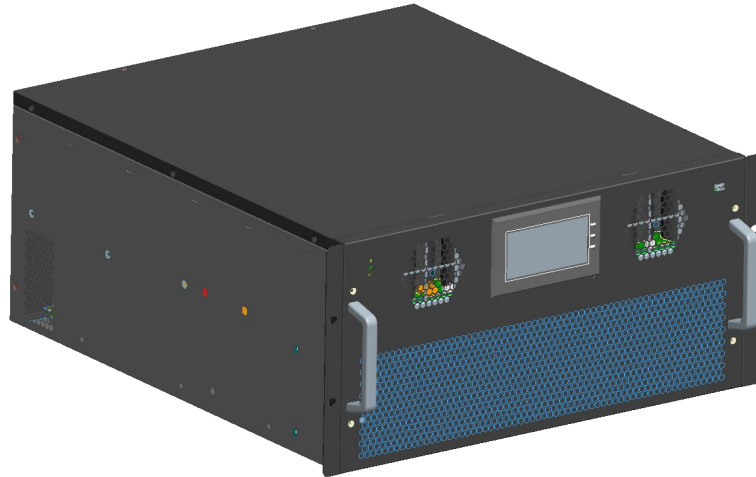

(2) wall-mounted

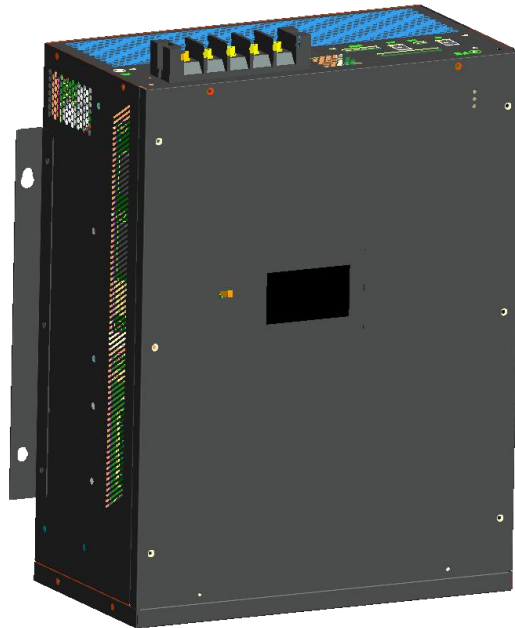

(3) Vertical

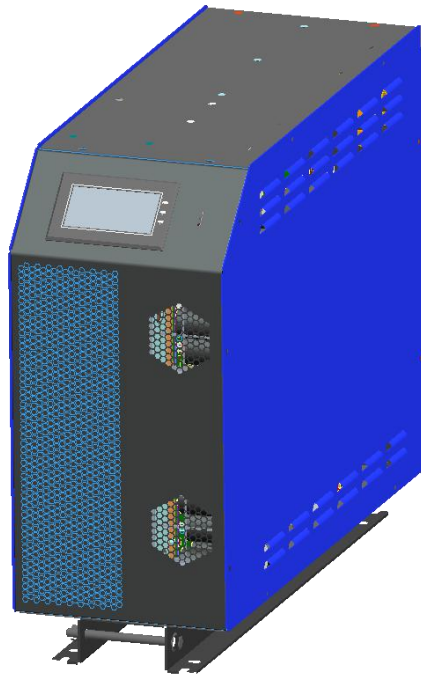

2. Background forwarding instructions and interface definition

Background forwarding refers to the function of sending APF device data collected on the large screen or directly to other receiving devices through customized cables. Currently, only "one-to-one" forwarding is supported, that is, data sent by one large screen or one APF can only be received by one device (upper computer, background terminal, etc.).

(1) Large-screen forwarding

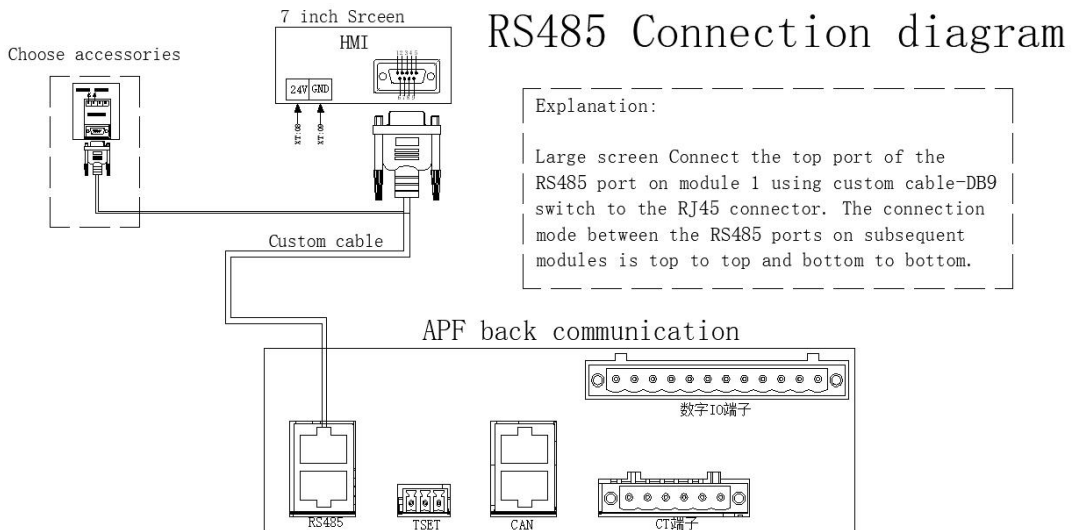

When data forwarding is carried out through the large screen, the DB9 male connector at one end of the customized cable can be connected to the female connector of the large screen, and the 8P crystal connector at the other end can be connected to the RS485 upper port of the APF device. The large screen also has a group of 485 signals that can be connected to the upper computer or background terminal

through the adapter.

(2) APF device forwarding

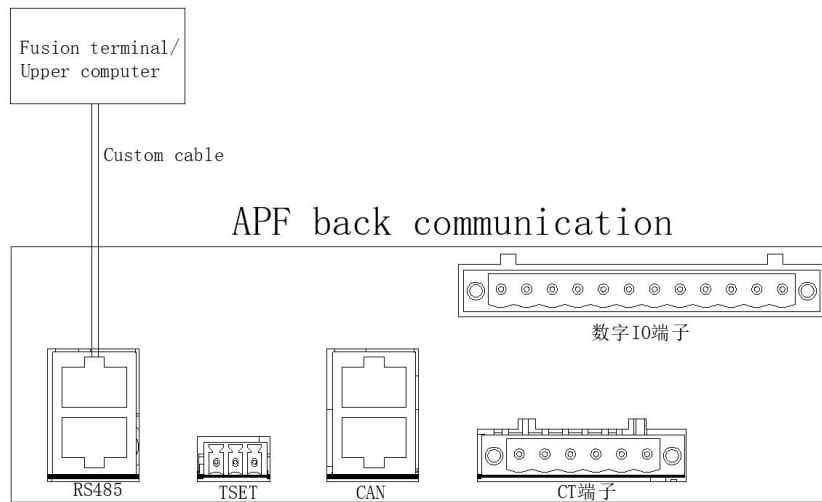

When the APF device is not connected to the external large screen but independently forwards data, the 8P crystal connector on one end of the customized cable is connected to the upper RS485 port of the APF device, and the other end is connected to the RS485 cable. 485A/485B is connected to the upper computer or background terminal to realize data forwarding.